

Inclusive Diffraction at H1



Paul Thompson
Birmingham University



- Diffraction at HERA
- Measurement technique
 - Latest measurements
 - Effective $\alpha_{IP}(0)$
- Q^2 and β dependences
 - QCD analysis
 - Summary

Diffraction DIS at HERA

Study QCD Structure of high energy diffraction using $\gamma^* p \rightarrow X p$

Standard DIS

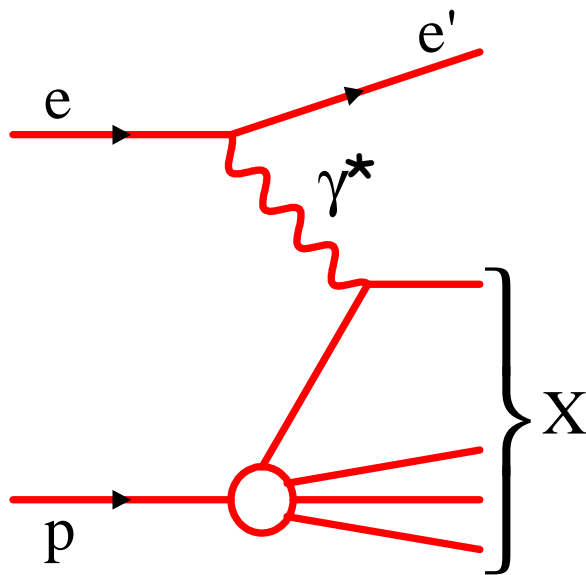

Probe proton $\rightarrow F_2$ Proton

Diffraction DIS

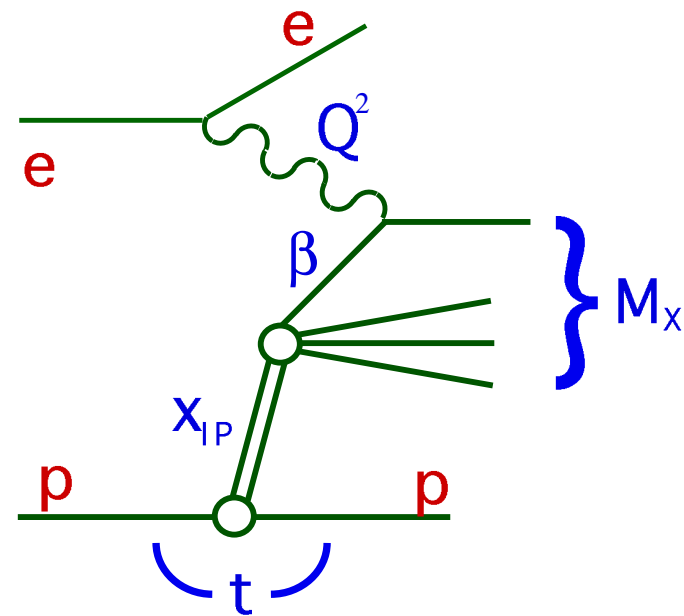

Probe the Pomeron $\rightarrow F_2^D$

Diffractive Kinematics

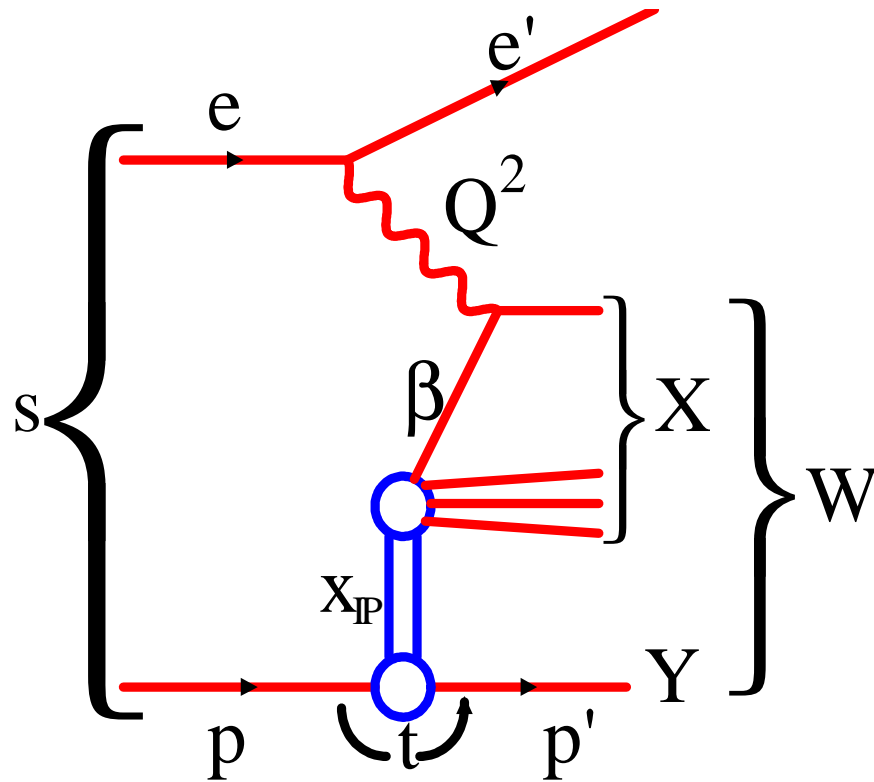

$$Q^2 = -(e - e') = -q^2$$

$$t = (p - p')^2$$

$$\beta = x_{\text{quark/IP}}$$

$$x_{IP} = x_{IP/\text{proton}}$$

$$x_{\text{Bjorken}} = \beta \cdot x_{IP}$$

Cross section:

$$\frac{d\sigma^{ep \rightarrow eXY}}{d\beta dx_{IP} dt} = \frac{4\pi \alpha^2}{\beta Q^4} \left(1 - y + \frac{y^2}{2}\right) \sigma_r^{D(4)}$$

Reduced Cross Section:

$$\sigma_r^{D(4)} = F_2^{D(4)} - \frac{y^2}{1 + (1 - y)^2} F_L^{D(4)} \quad (\sigma_r^{D(4)} = F_2^{D(4)} \text{ if } F_L^{D(4)} = 0)$$

Overview of $\sigma_r^{D(3)}$ measurements at H1

New data at Low Q^2 , $\ell = 3.4 \text{ pb}^{-1}$

New H1 Measurements at Low and High Q^2

Good agreement between measurements.

Data well described by QCD Fit (more later)

New data at High Q^2 , $\ell = 65 \text{ pb}^{-1}$

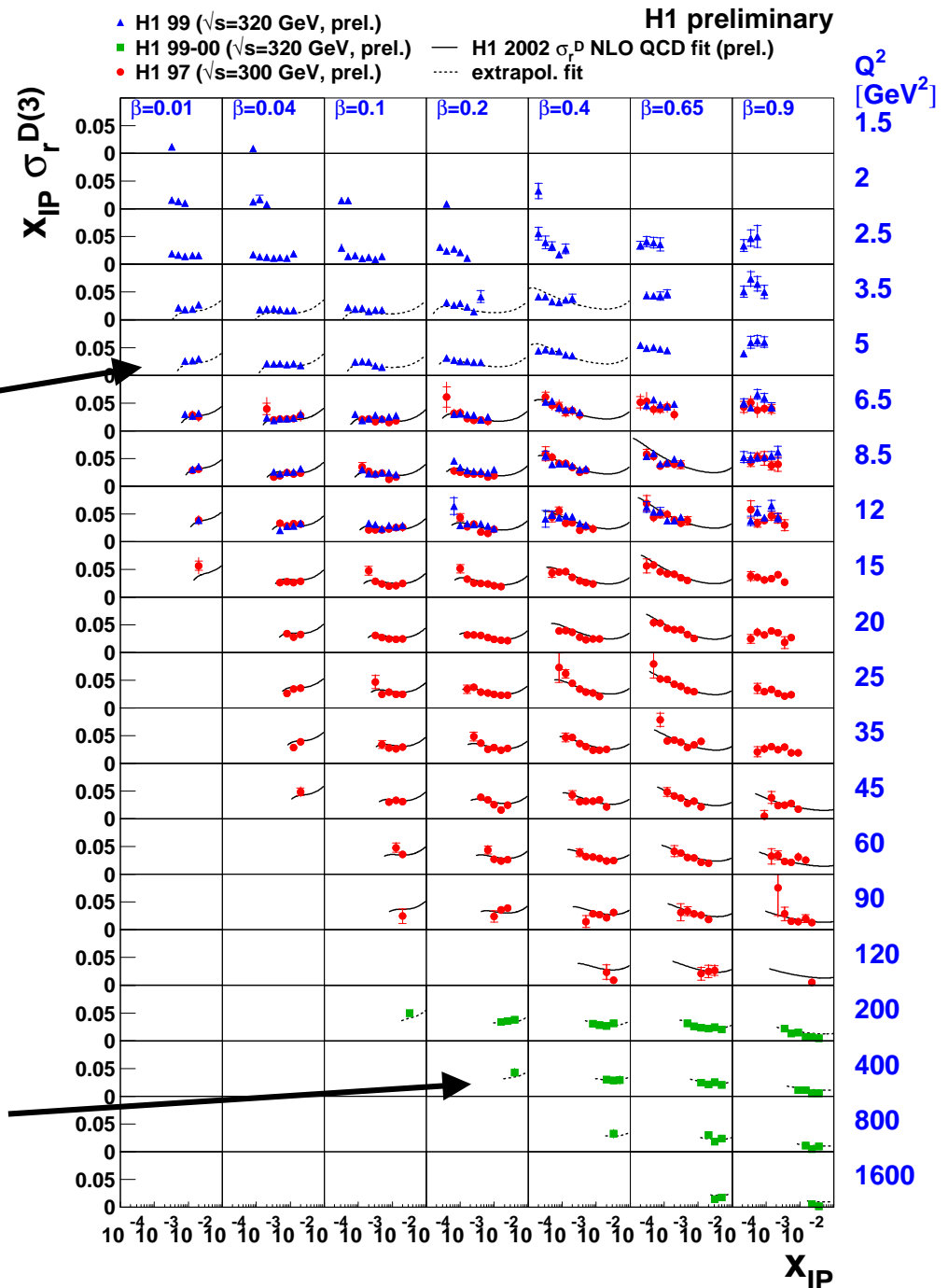

Factorisation of $\sigma_r^{D(3)}$

QCD Hard Scattering Factorisation for Diffractive DIS (Collins)

-At fixed x_{IP}, t , Diffractive Parton Densities $p(x, Q^2)$ evolve with x and Q^2 via DGLAP equations

Regge Factorisation

-shape of diffractive PDFs independent of x_{IP} and t

-Regge motivated flux factor

$$f_{IP/p}(x_{IP}) = \int_{t_{cut}}^{t_{min}} \frac{e^{Bt}}{x_{IP}^{2\alpha(t)-1}} dt$$

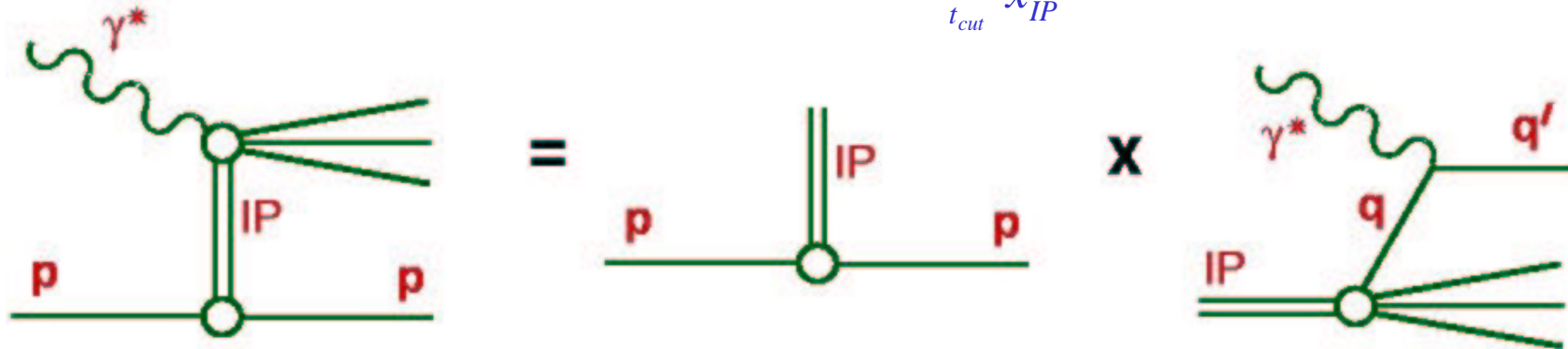

$$\sigma(\gamma^* p \rightarrow Xp) \approx f(x_{IP}, t) \otimes p(\beta, Q^2) \otimes \hat{\sigma}(\beta, Q^2)$$

Test of Regge Factorisation

$$x_{IP} F_2^D \approx A(\beta, Q^2) x_{IP}^{-2(\alpha(t)-1)}$$

Fit x_{IP} dependence at fixed β and Q^2

Avoid F_L $y < 0.45$

Data well described by exchange of Pomeron and Reggeon

$$\chi^2 / \text{ndf} = 0.95$$

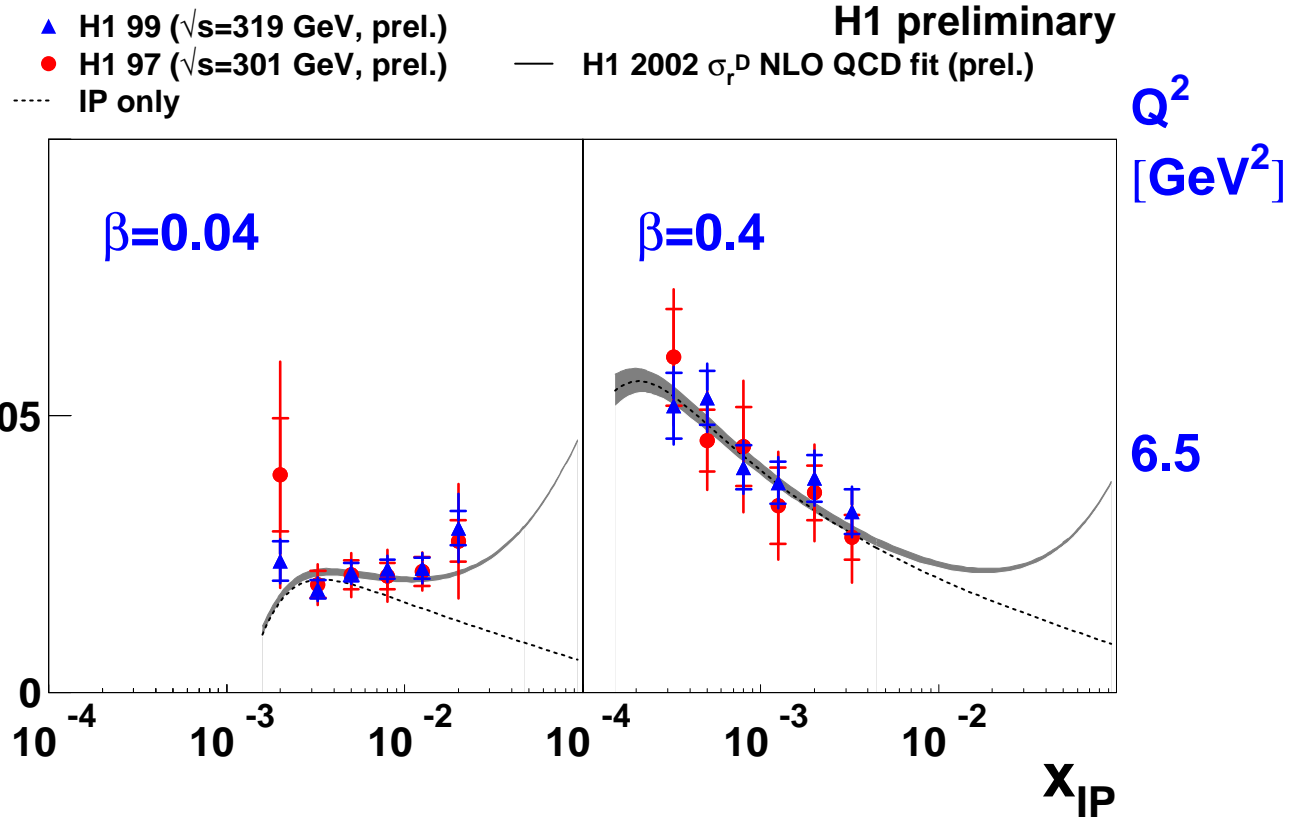

$$\alpha_{IP}(0) = 1.173 \pm 0.018 \text{ (stat.)}$$

$$\pm 0.017 \text{ (syst.)}_{-0.035}^{+0.063} \text{ (model)}$$

Effective $\alpha_{IP}(0)$

Possible increase with Q^2 ?

Limited by ignorance of F_L

Data inconclusive

Effective $\alpha_{IP}(0)$ at large Q^2
greater than for soft IP

$\alpha_{IP}(0)$ lower than for
inclusive cross section

$$x_{IP} F_2^D \approx A(\beta, Q^2) x^{-2(\alpha(t)-1)}$$

$$F_2 \approx B x^{-(\alpha(t)-1)}$$

H1 Diffractive Effective $\alpha_{IP}(0)$

● 97 prel ($F_L^D=0$)

▲ 99 prel ($F_L^D=0$)

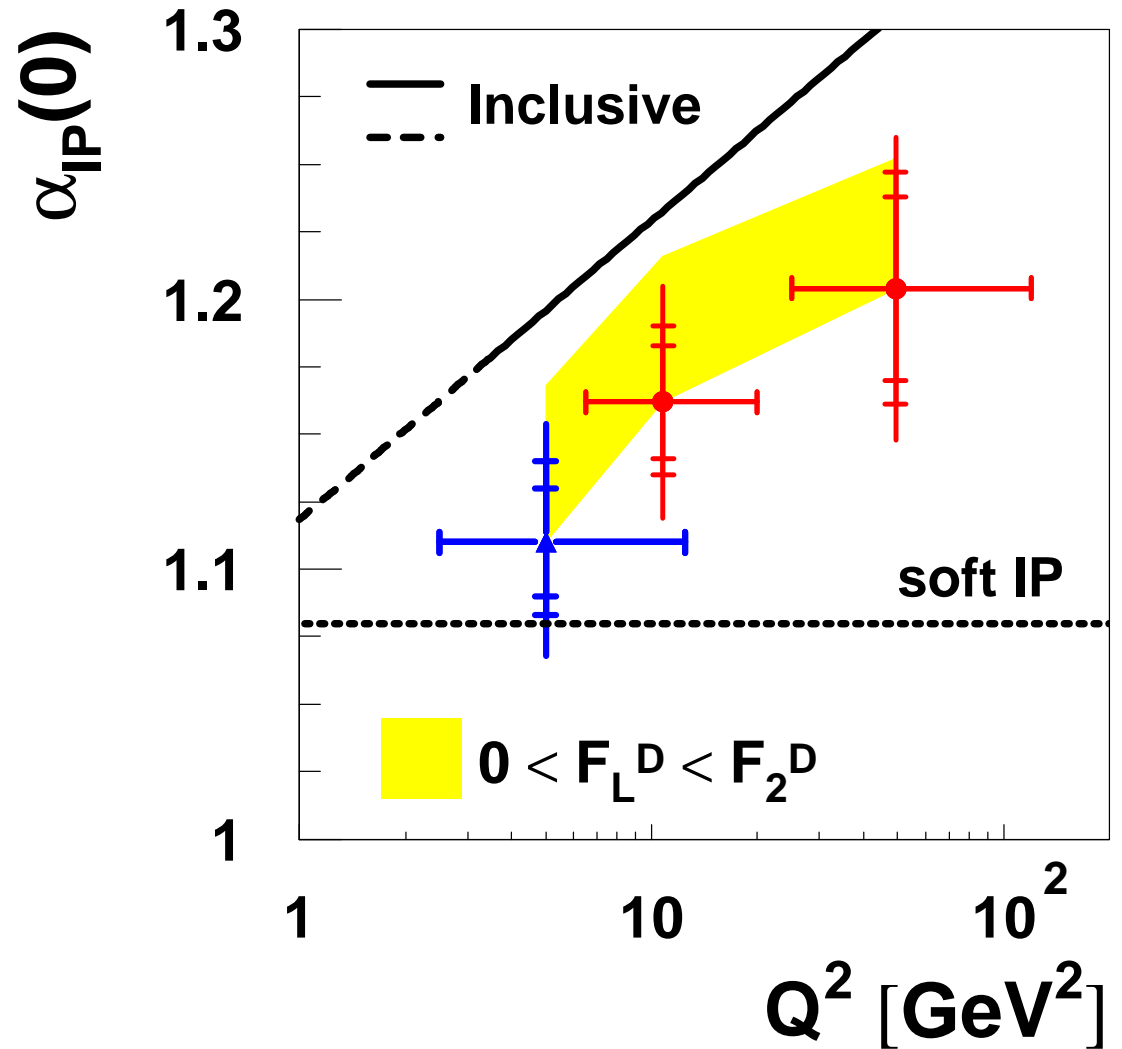

β Dependence of σ_r^D

H1 preliminary

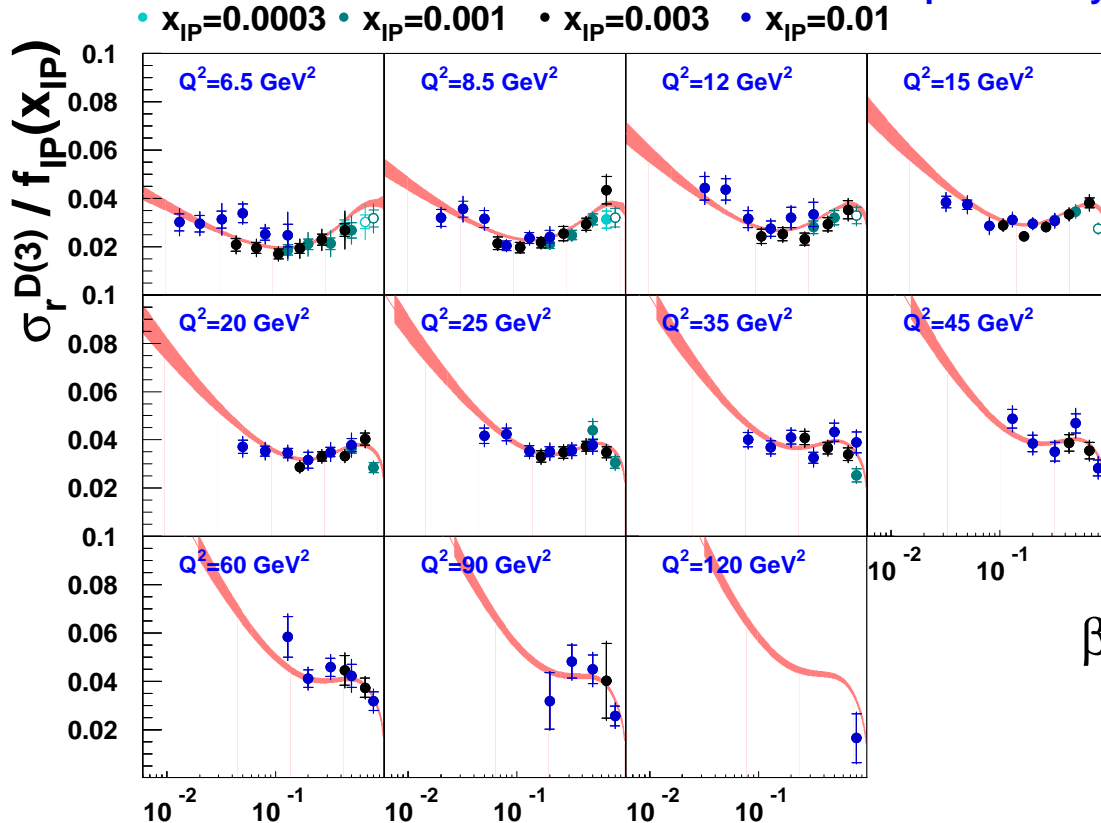

- H1 97 (prel.) $y < 0.6$
- H1 97 (prel.) $y < 0.6$; $M_X < 2 \text{ GeV}$
- H1 2002 σ_r^D NLO QCD Fit ($F_L^D=0$)

Divide by $f_{IP}(x_{IP})$

Compare different x_{IP} bins

β dependence relatively flat
 -> Gluon dominated

Structure similar
 at all values of x_{IP}
 -> supports Regge
 factorisation

$$F_2^{IP}(\beta, Q^2) = \beta \sum_i e_i^2 p_i(x, Q^2)$$

Q² Dependence of σ_r^D

H1 preliminary

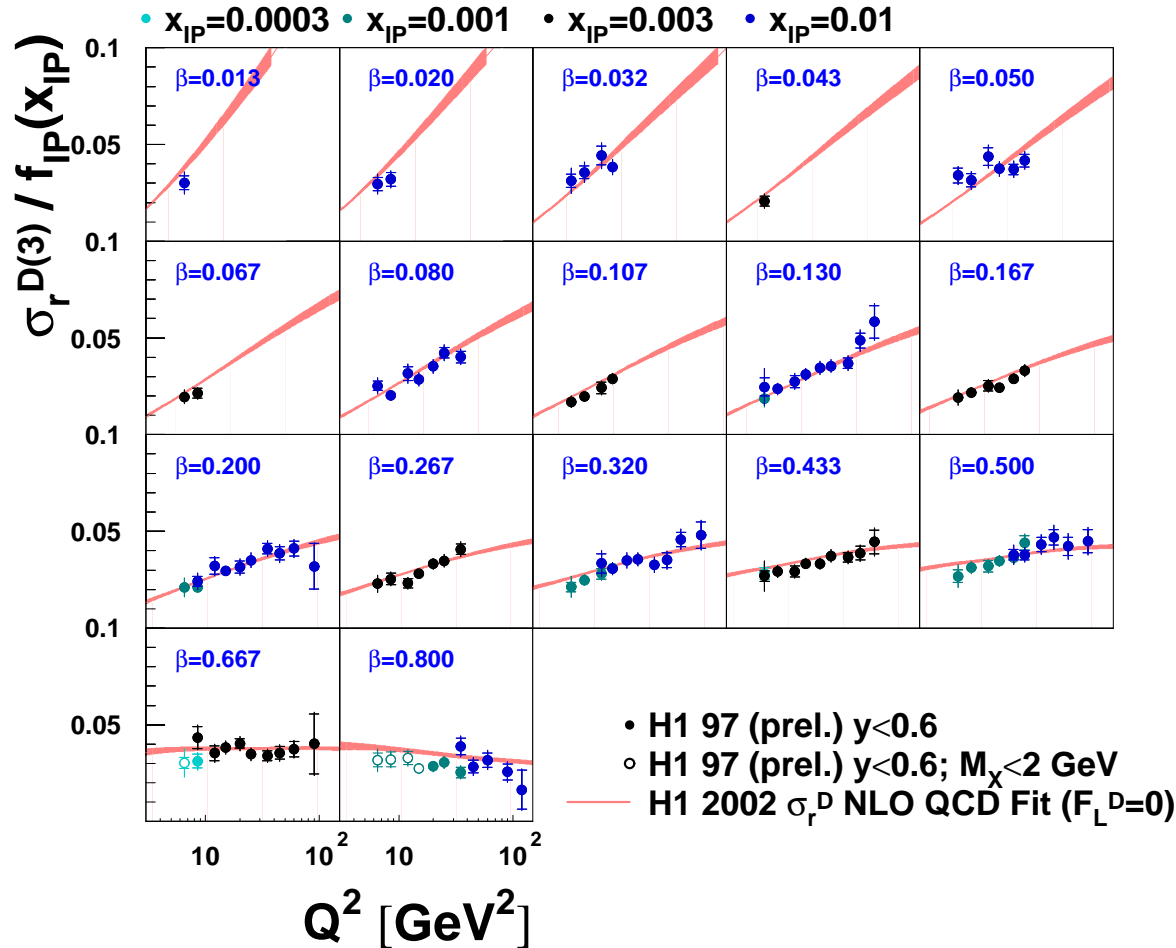

Divide by $f_{IP}(x_{IP})$
Compare different
 x_{IP} bins

Large +ve scaling violations
except at highest β
-> Gluon dominated

Scaling violations
similar at all
values of x_{IP}
-> supports Regge
factorisation

$$F_2^{IP}(\beta, Q^2) = \beta \sum_i e_i^2 p_i(x, Q^2)$$

Scaling Violations

H1 Preliminary

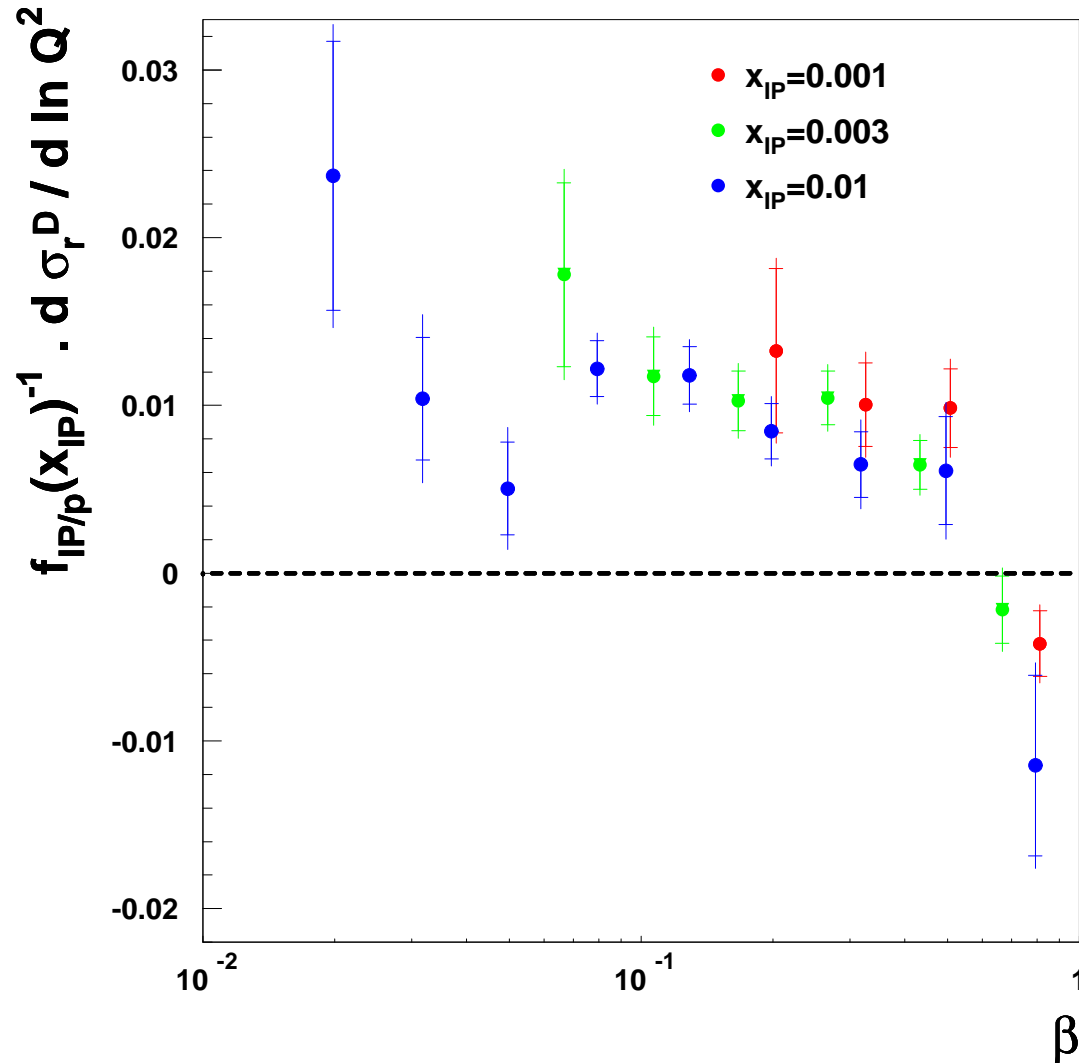

Quantify Scaling violations...

Divide by $f_{IP}(x_{IP})$

$$\sigma_r^D = A + B \ln Q^2$$

$$B = \frac{d\sigma_r^D}{d \ln Q^2 (\sigma_r^D)}$$

Large +ve Scaling violations until $\beta \sim 0.6$

Comparison with inclusive DIS

H1 Preliminary

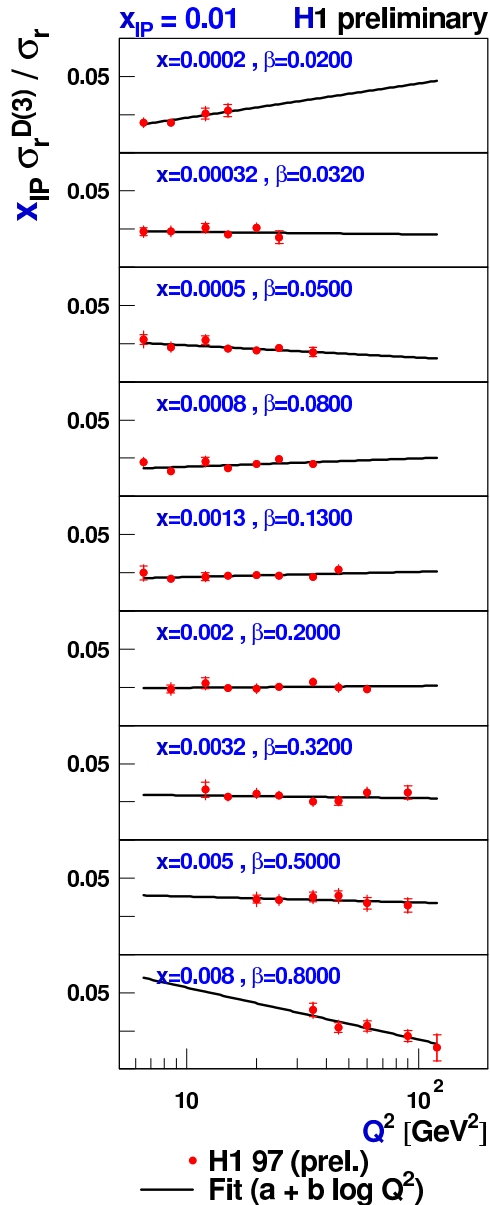

$$x = x_{IP} \cdot \beta$$

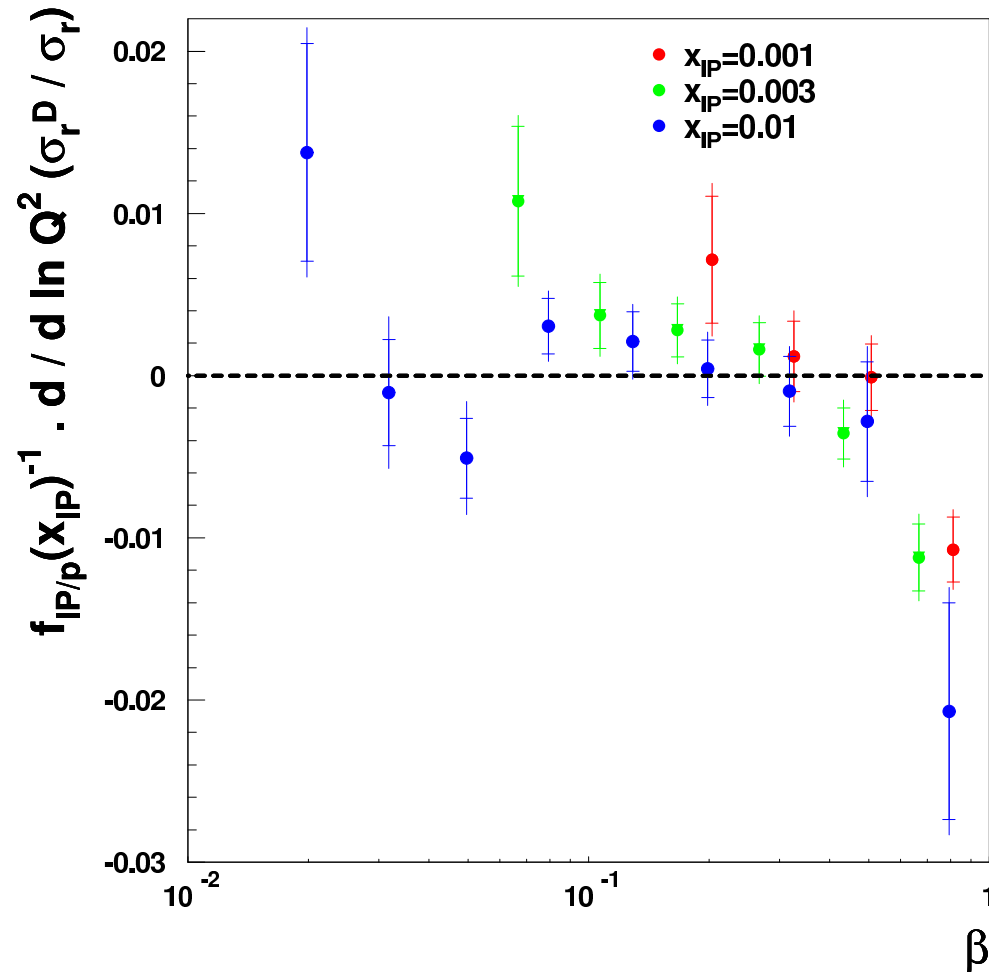

Fit $R = a + b \ln Q^2$, $\sigma_r^D / \sigma_r \sim$ flat vs Q^2

Similar Q^2 dynamics?

Diffractive Parton Densities

H1 2002 σ_r^D NLO QCD Fit

H1 preliminary

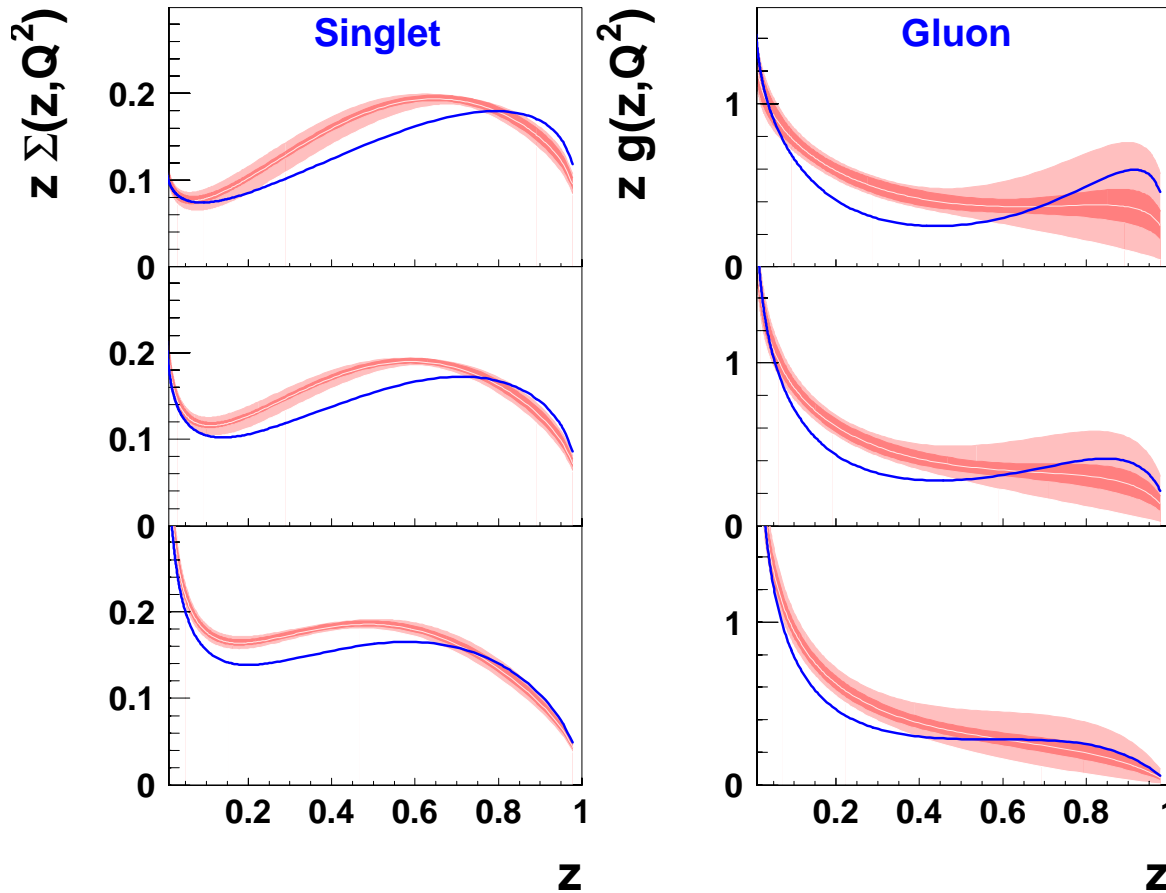

Q^2
[GeV²]

-Fit data: $Q^2 > 6.5 \text{ GeV}^2$

6.5

- $M_x > 2 \text{ GeV}$ (leading twist)

- x_{IP} /Regge factorisation

-DGLAP evolution

15

-LO fit: $y < 0.45$

-NLO fit: F_L^D and full propagation of errors

90

H1 2002 σ_r^D NLO QCD Fit
■ (exp. error)
■ (exp.+theor. error)
— H1 2002 σ_r^D LO QCD Fit

z : parton momentum fraction w.r.t. IP

-Diffractive PDF
Gluon dominated

-Extend to large z

-Large uncertainty on gluon at high z

QCD Fit

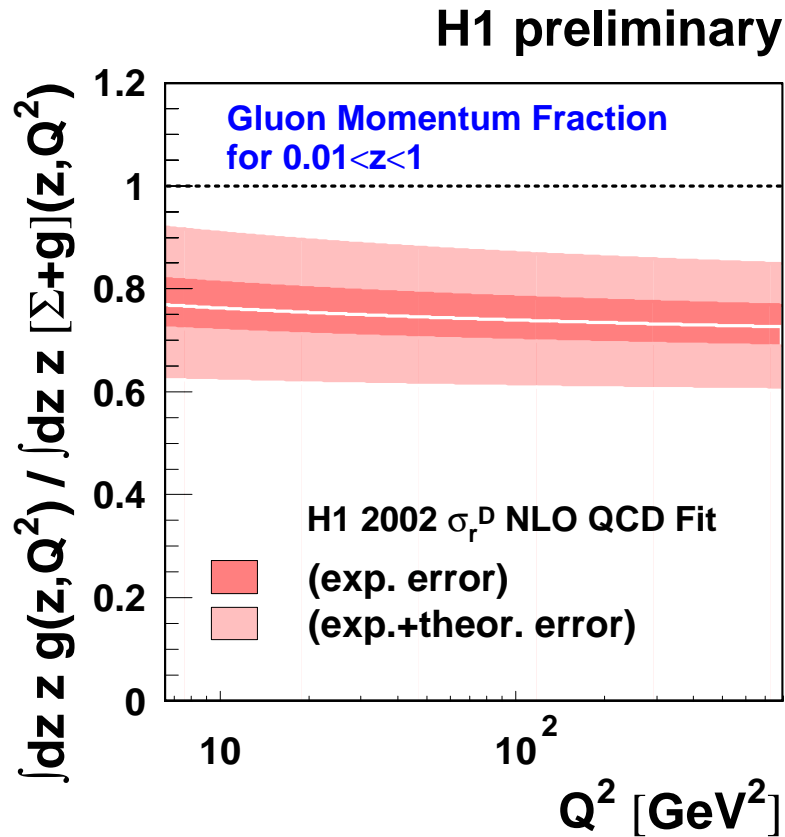

75 ± 15% diffractive exchange carried by gluons

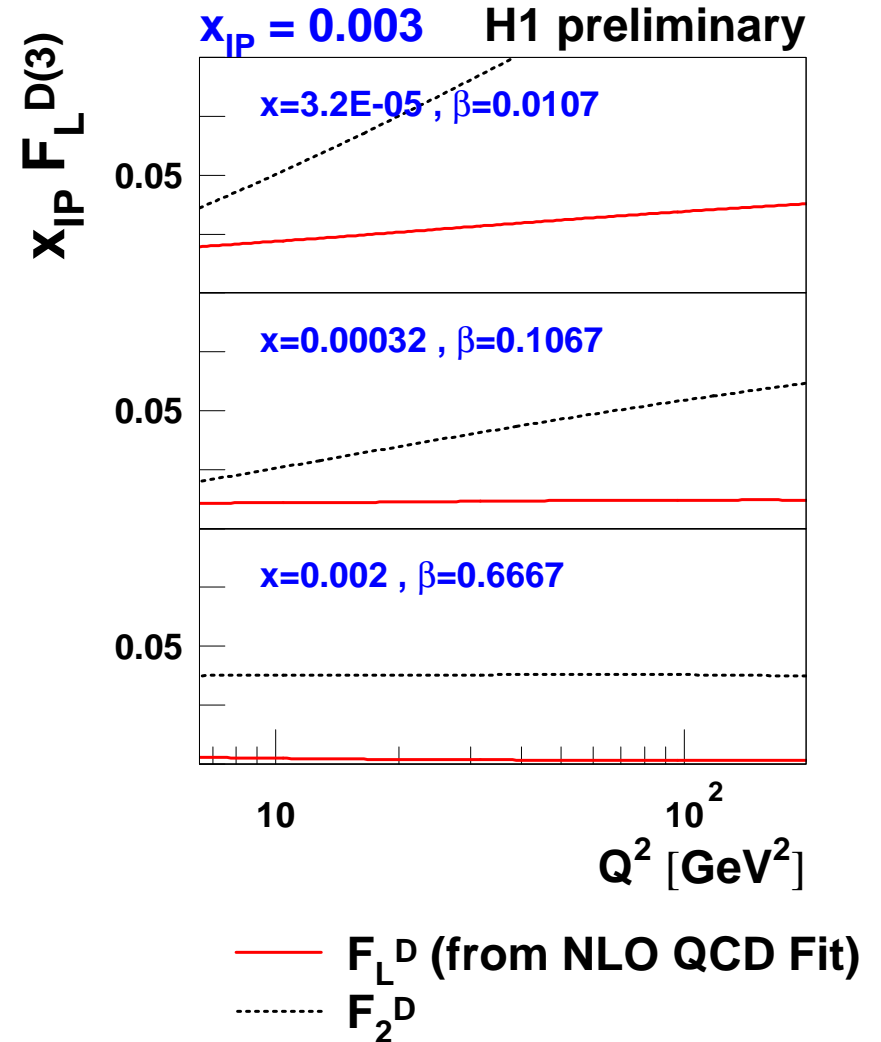

F_L^D predicted at leading twist
 -> large at low Q^2 and low β

New Measurement at High Q^2

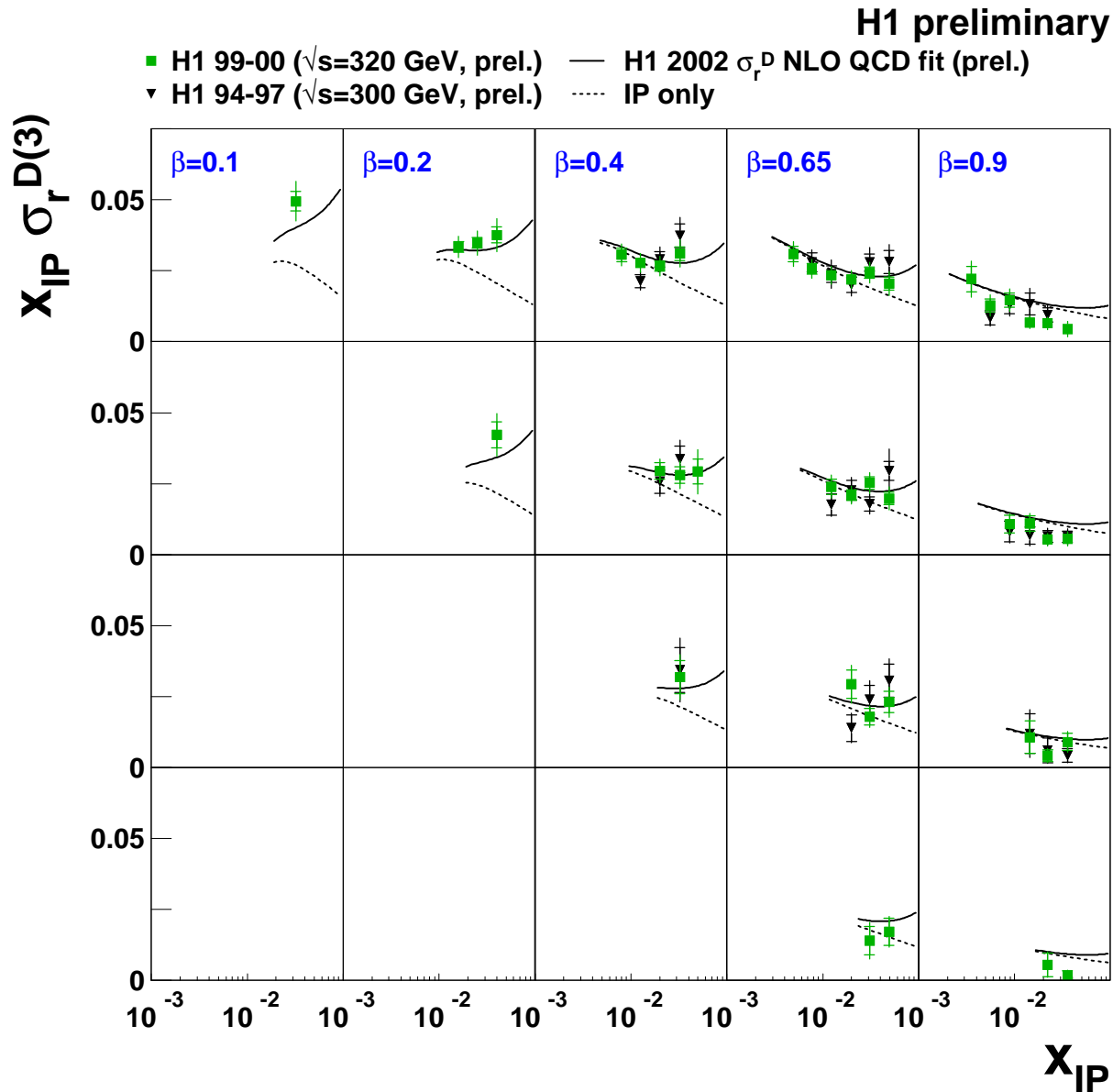

Q^2
[GeV²]

200 Improved statistics and kinematic range of 99-00 measurement compared with 94-97

-> *Good agreement*

400

Prediction of NLO fit to medium Q^2 data

800

-> *Good agreement*

1600

Subleading trajectory needed at high x_{IP} and low β

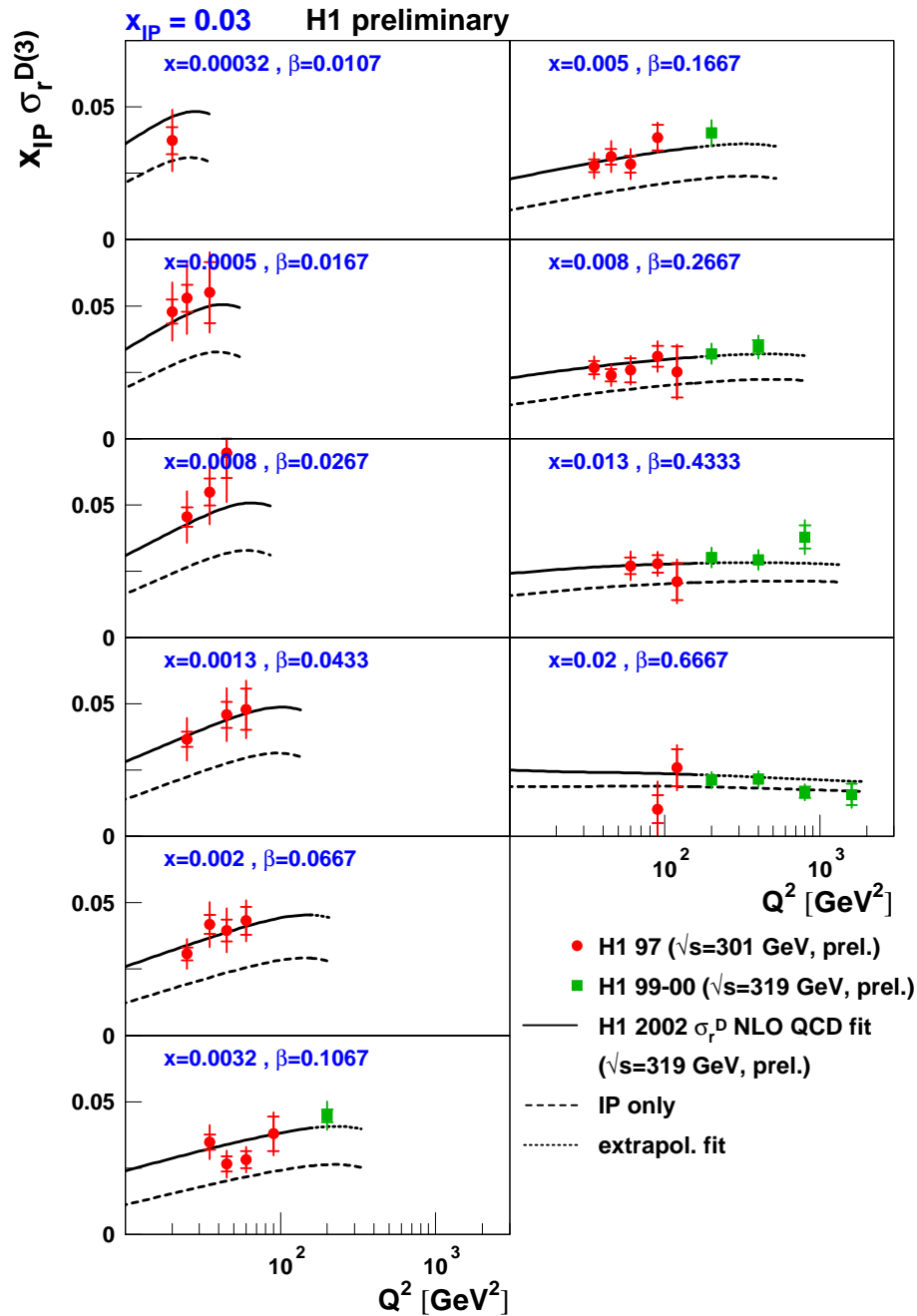

Q^2 Dependence at high x_{IP}

Extrapolation of the fit over an order of magnitude in Q^2 !!!

-> Good description of the data

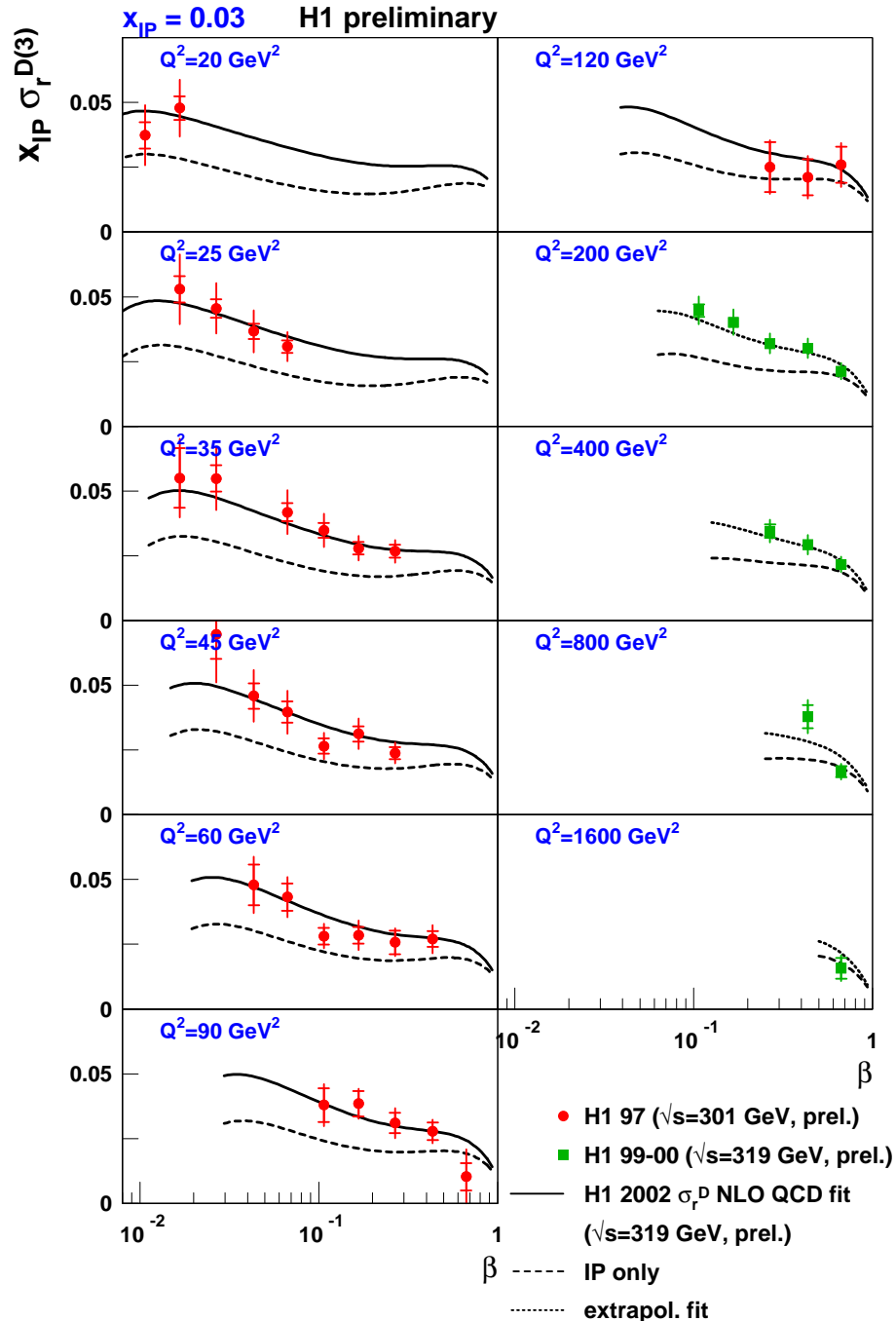

β Dependence at high x_{IP}

Meson exchange has negative slope

← New data at high Q^2 will provide constraint to future fits

β Dependence at low x_{IP}

New data at low Q^2 will provide important constraint to future fits

Good agreement between medium and low Q^2 data

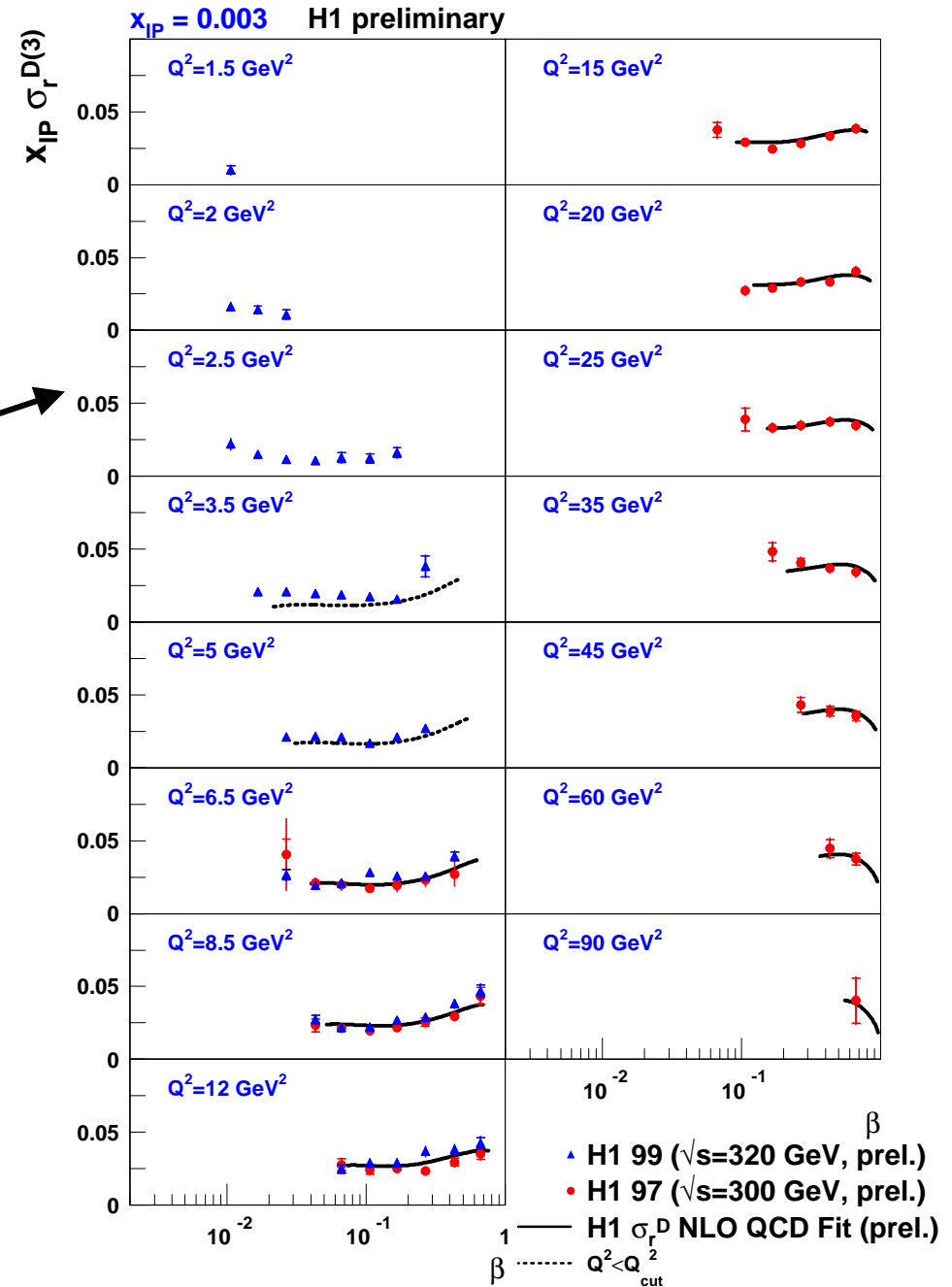

Summary

- New measurements from H1 at low and high Q^2
- Data will provide further constraints for fits and models
 - $\alpha_{IP}(0)$ in diffractive DIS larger than soft Pomeron
- NLO QCD fit yields PDFs dominated by gluon to large β
 - Similar Q^2 dynamics to inclusive DIS at medium β

High Precision measurement of $F_2^{D(3)}$ combined with
QCD factorisation theorem:

tools for pQCD to provide complete description of
diffractive final state as for inclusive DIS?