

JETS IN ep AND γp INTERACTIONS AT HERA

Thomas Schörner-Sadenius
Hamburg University

on behalf of



Photon 2005, 31.8. - 4.9.2005
Warsaw University



MOTIVATION AND OUTLINE



... from "simple" to more and more complex

Cross-section measurements

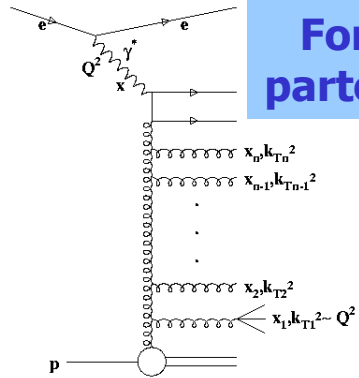
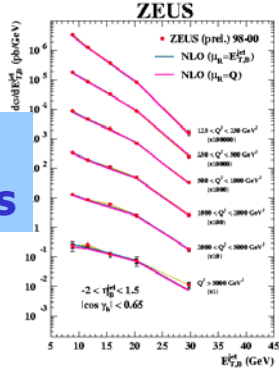

Extraction of QCD parameters

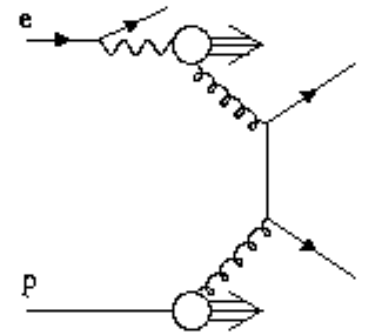
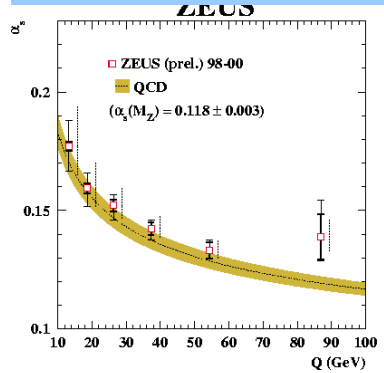

I will mainly concentrate on new results since ICHEP04.

JET PHYSICS AT HERA



The basic processes, kinematics

QPM process

→ F2, PDFs

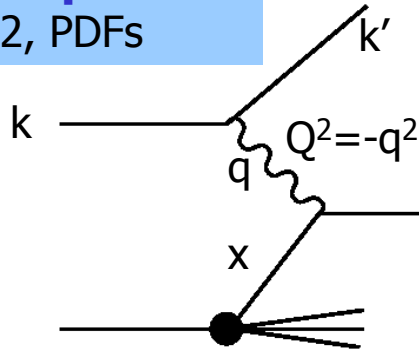

$$Q^2 = -(k - k')^2$$

$$x = Q^2 / 2Pq$$

$$y = 1 - E'/E$$

$$Q^2 = xys$$

Real+virtual corrections:

NLO QCD, $O(\alpha_s^2)$

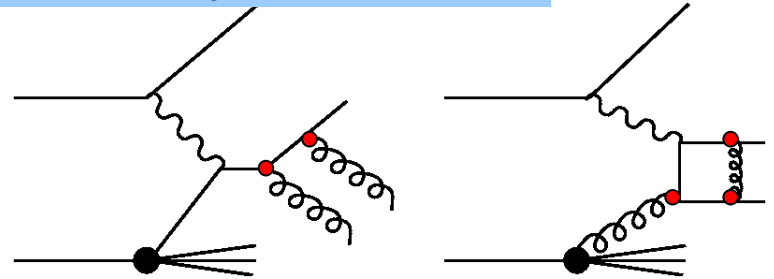

QCD-C and BGF processes:

Leading-order QCD, $O(\alpha_s)$.

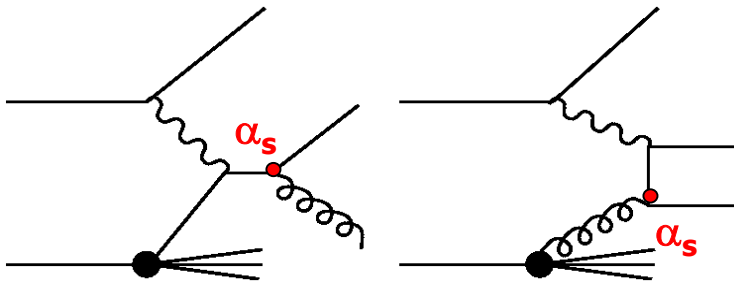

$$\sigma \sim \hat{\sigma}_{\gamma} \otimes f_{i/p}$$

Resolved photon contributions:

Suppressed with increasing Q^2

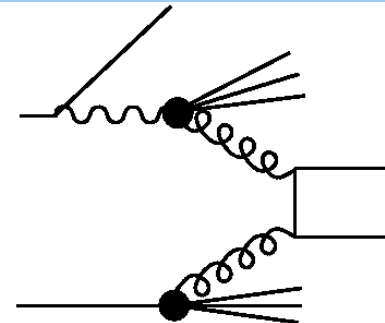

$$\sigma \sim f_{i/\gamma} \otimes \hat{\sigma}_{ij} \otimes f_{j/p}$$

■ **Jet reconstruction**

- almost always with inclusive k_{\perp} algorithm on calorimeter cells or energy flow objects (cells+ tracks \rightarrow improved resolution).
- DIS analysis mostly performed in Breit frame \rightarrow select events with QCD coupling.
- Data correction using LO MC models (acceptance, efficiency, hadronisation, QED)

■ **Main experimental uncertainty: hadronic jet energy scale:**

- know to between 1-3%! Typical effect on measurements: 5-10%.

■ **Theoretical predictions for jet physics at HERA:**

- LO MCs + models for parton radiation (PYTHIA, RAPGAP, ARIADNE): good for soft, small-angle phenomena, does not provide normalisation, includes detector simulation, hadronisation etc.
- Fixed-order QCD calculations (up to NLO, DISENT, JetViP, FMNR etc.) describes hard physics well, no hadronisation, detector simulation, QED effects

■ **Theoretical uncertainties dominate many measurements.**

INCLUSIVE, 2, 3 JETS AT HIGH Q^2



Well understood phase-space with high scales \rightarrow pQCD!

Typical scenario:

- $Q^2 > 125 \text{ GeV}^2$, $E_{T,\text{jet}} > 8 \text{ GeV}$
- Measurements dominated by theoretical uncertainties (scale)!
- Full HERA-I data sets ($80\text{-}120\text{pb}^{-1}$)

ZEUS 2,3 jets

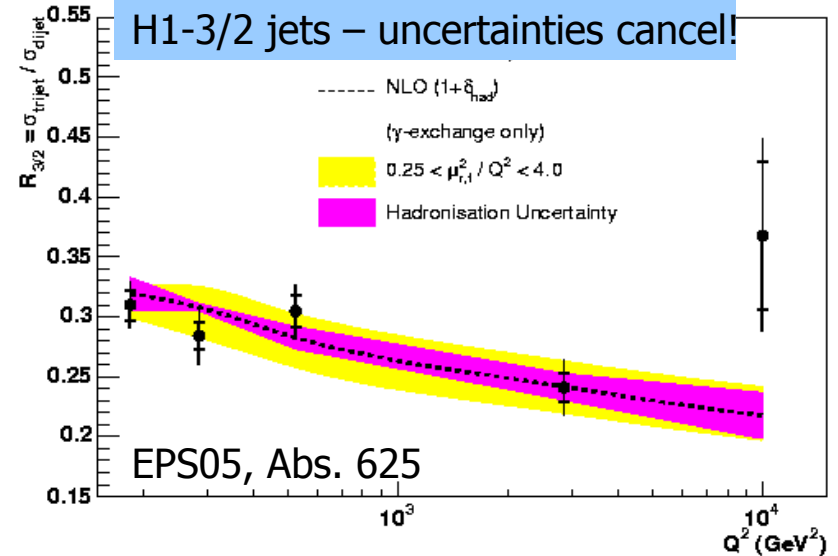
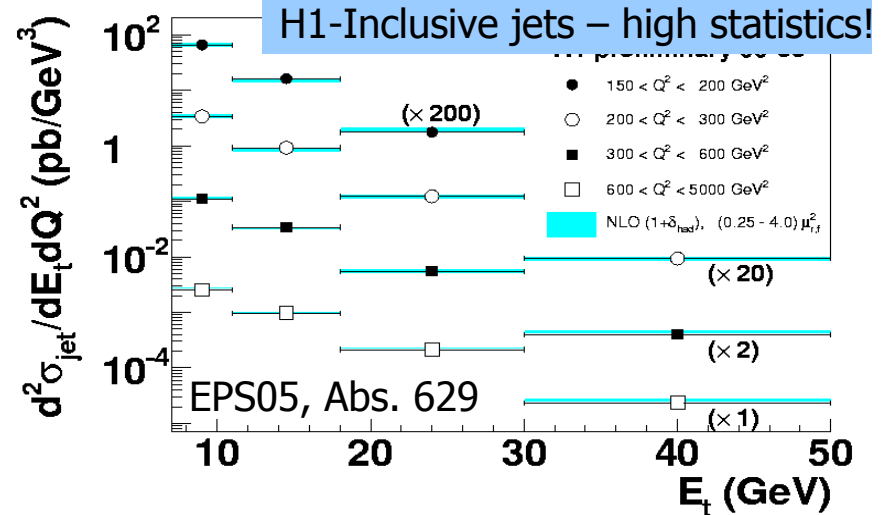
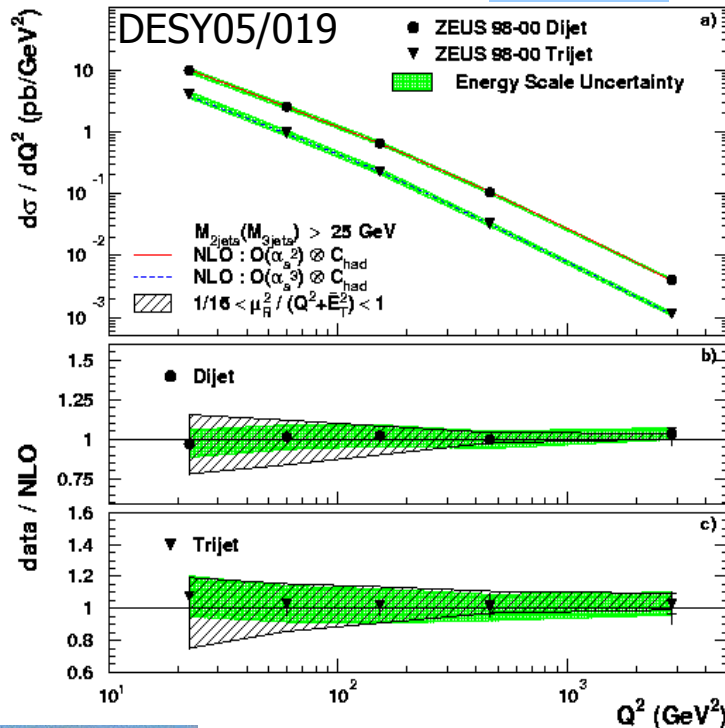

2 JETS IN PHOTOPRODUCTION (H1)

Further constraining the PDFs?

Emphasis on x_γ and x_p :

→ learn something about PDFs, especially gluon at high x

$$x_\gamma = \left(\sum_i E_{T,i} \exp(-\eta_i) \right) / 2yE_e$$

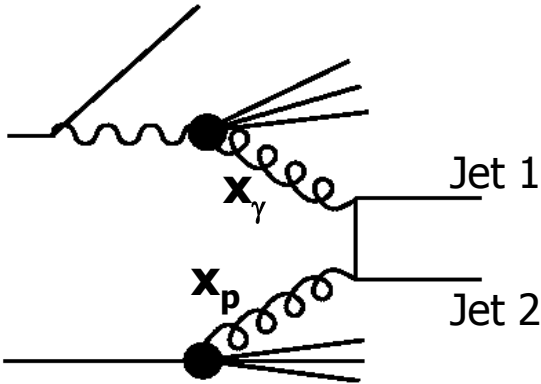

$$x_p = \left(\sum_i E_{T,i} \exp(+\eta_i) \right) / 2E_p$$

Good description of data over wide kinematic range by both the MC and NLO calculation.

Data give access to proton PDF (used by ZEUS in QCD fits)

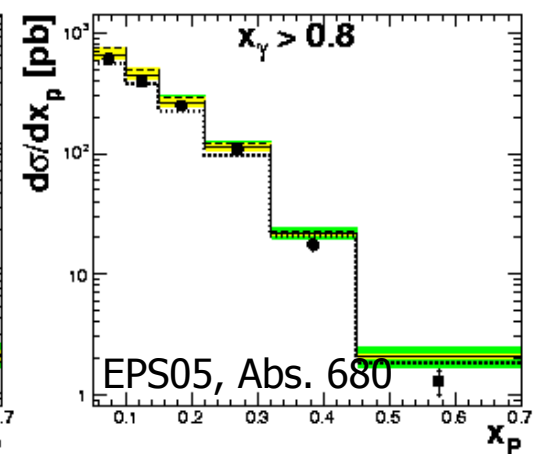
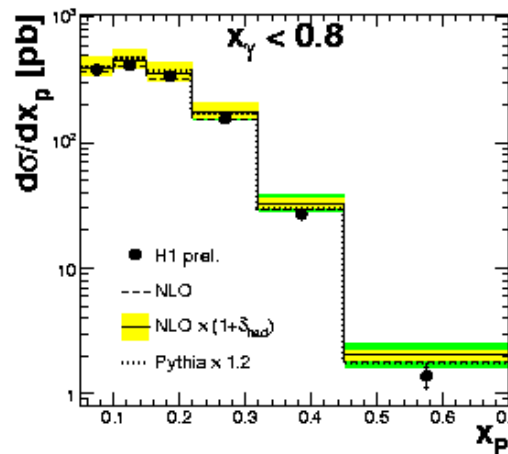
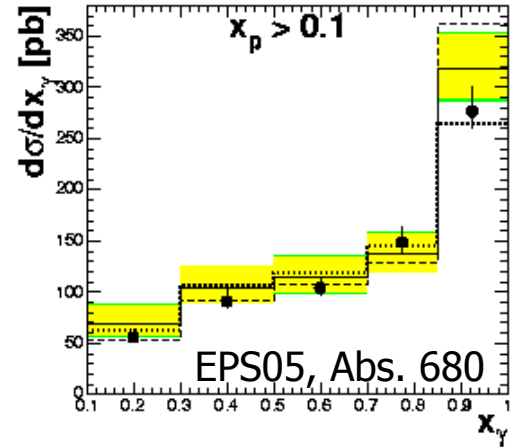
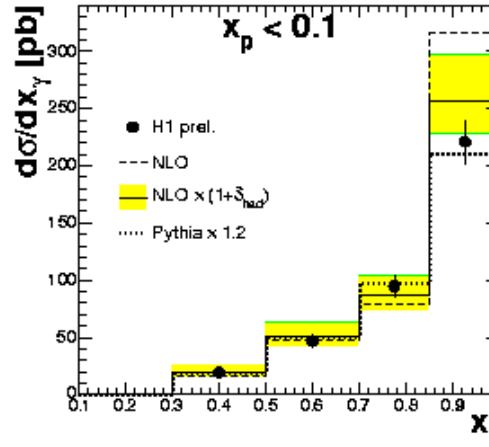

α_s FROM JETS AT HIGH Q^2



The Method

- **Determine dependence of cross-section on $\alpha_s(M_Z)$ in each bin using NLO calculations with different input $\alpha_s(M_Z)$ values.**
-- use, for example, MRST or CTEQ4 (3/5 different α_s values, 0.110 to 0.122).

- **Functional dependence on $\alpha_s(M_Z)$ then approximated by the function**

$$\sigma_i(\alpha_s(M_Z)) = A_i \cdot \alpha_s(M_Z) + B_i \cdot \alpha_s^2(M_Z)$$

-- A_i, B_i determined in the fit.

- **Use function to map measured cross-section to value of $\alpha_s(M_Z)$.**

- evolve to correct scale
- combine various data points, using, for example, a χ^2 fit.

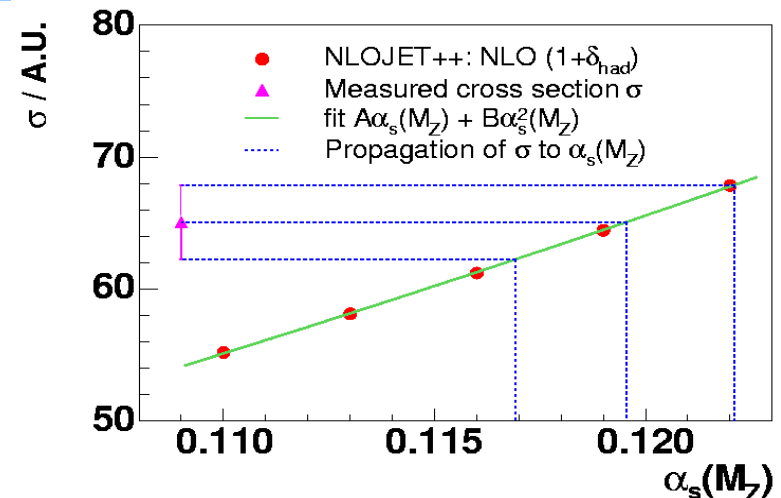

α_s FROM JETS AT HIGH Q^2



Results

α_s from inclusive jets:
small theoretical uncertainty!

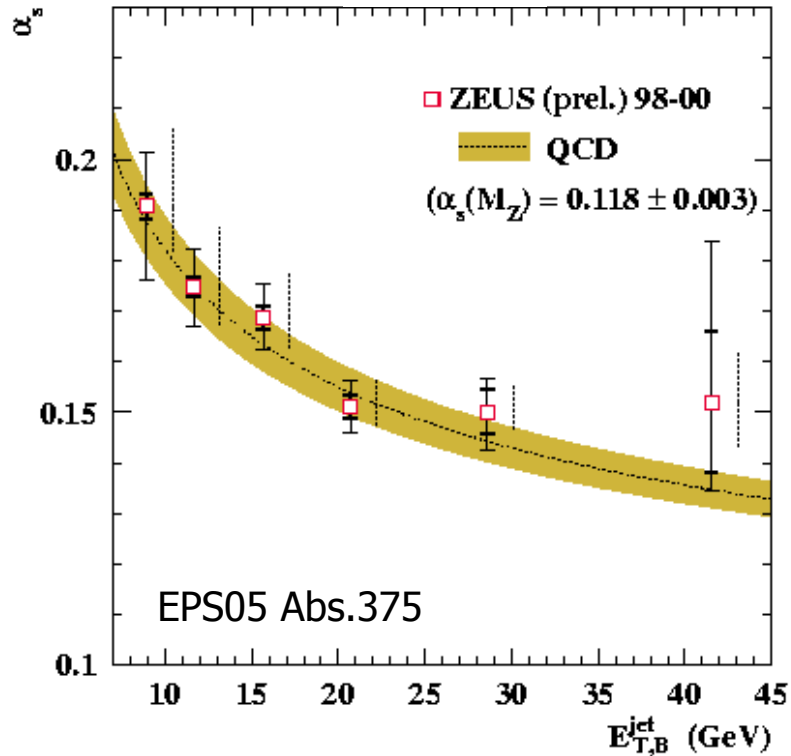

α_s from ratio $\sigma_{3jet}/\sigma_{2jet} \rightarrow$
some uncertainties cancel out!

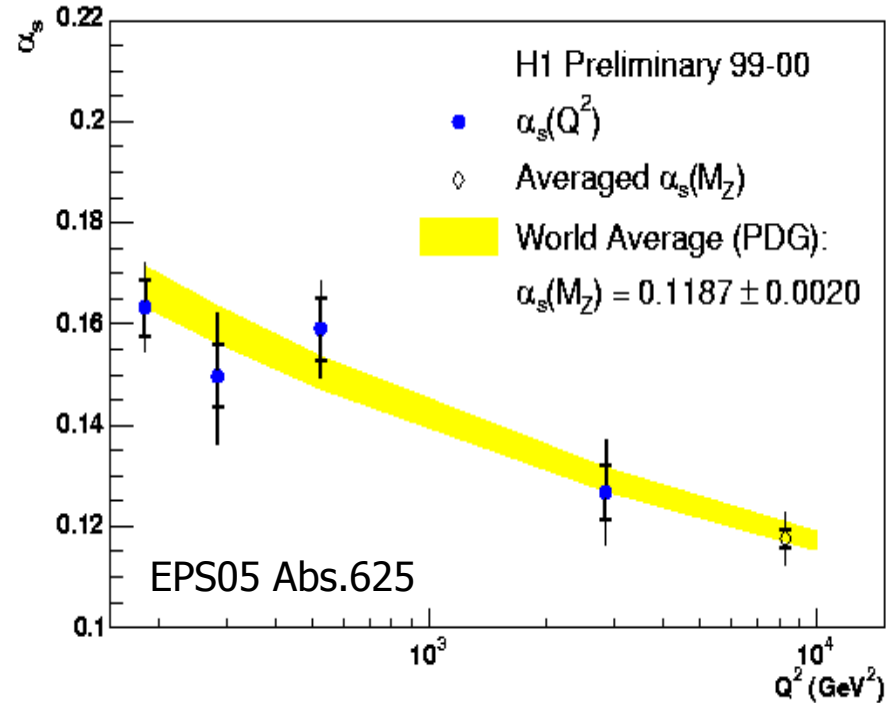

World average: $\alpha_s(M_Z) = 0.1187 \pm 0.0020$
 H1 inclusive jets: $\alpha_s(M_Z) = 0.1197 \pm 0.0016(\text{exp}) \pm 0.0047(\text{theo})$
 H1 3/2jet ratio: $\alpha_s(M_Z) = 0.1175 \pm 0.0053(\text{exp}) \pm 0.0061(\text{theo})$
 ZEUS inclusive: $\alpha_s(M_Z) = 0.1196 \pm 0.0025(\text{exp}) \pm 0.0023(\text{theo})$

**Nice agreement!
Errors going down!**

α_s FROM JETS AT HIGH Q^2



Summary plots for HERA measurements

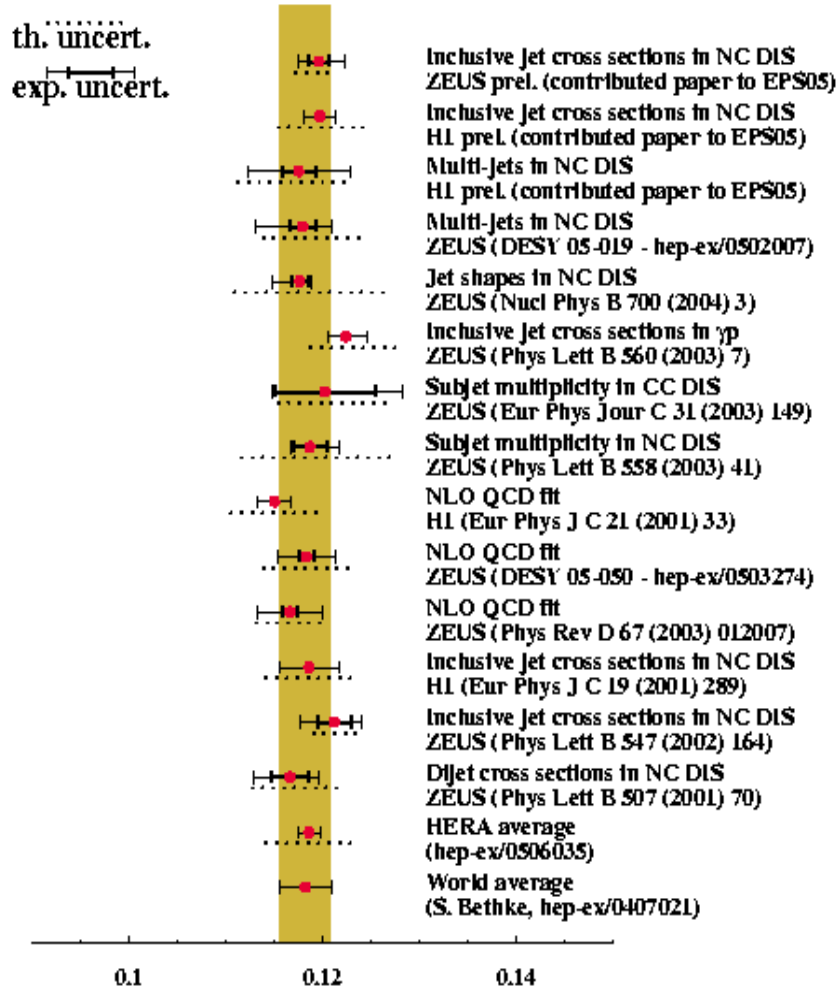

(C. Glasman, hep-ex/0506035) $\alpha_s(M_Z)$

Many consistent results

→ nice QCD test!

Typical errors:

theoretical: 4-8%

experimental: 3%

HERA average:

$$\alpha_s(M_Z) = 0.1186 \pm 0.0011 \pm 0.0050$$

Ratio $\sigma_{\text{exp}}/\sigma_{\text{theo}}$:

$$0.0011 / 0.0050 \text{ !!!!}$$

Errors of world / HERA average
are becoming comparable!

GLOBAL QCD FITS



Supplement inclusive F_2 data to improve on $q(x)$, $xg(x)$

- **Usual global QCD fits:**

Only inclusive input data → large uncertainty in gluon density at high x (basically only constrained by Tevatron jets data): 15% at $x=0.3$, 200% at $x=0.5$.

- **Jet data sensitive to high x ,**

but use in fits difficult (CPU time: 10h/50M events)

- **Idea: Use grids in x , μ_F^2 in which PDFs are approximately flat:**

$$\sigma = \sum_{m=1}^2 \alpha_s^m(\mu_r) \sum_{a=-5}^5 \int dx \cdot f_a(x, \mu_f) \cdot \hat{\sigma}(x_{Bj} / x, \mu_r, \mu_f)$$

$$\sim \sum_{m=1}^2 \alpha_s^m(\mu_r) \sum_{a=-5}^5 \sum_i \sum_j f_a(x_i, \mu_{f,j}) \cdot \int dx_i \cdot \hat{\sigma}(x_{Bj} / x_i, \mu_r, \mu_{f,j})$$

- **Derivation of total cross-section:**

Sum over PDF × pre-calculated integrals over matrix elements for all x , μ_F^2 bins.

→ calculation time reduced from 10h to 0.01s → usable in fits!!!

GLOBAL QCD FITS



Results, comparison with H1, extraction of strong coupling

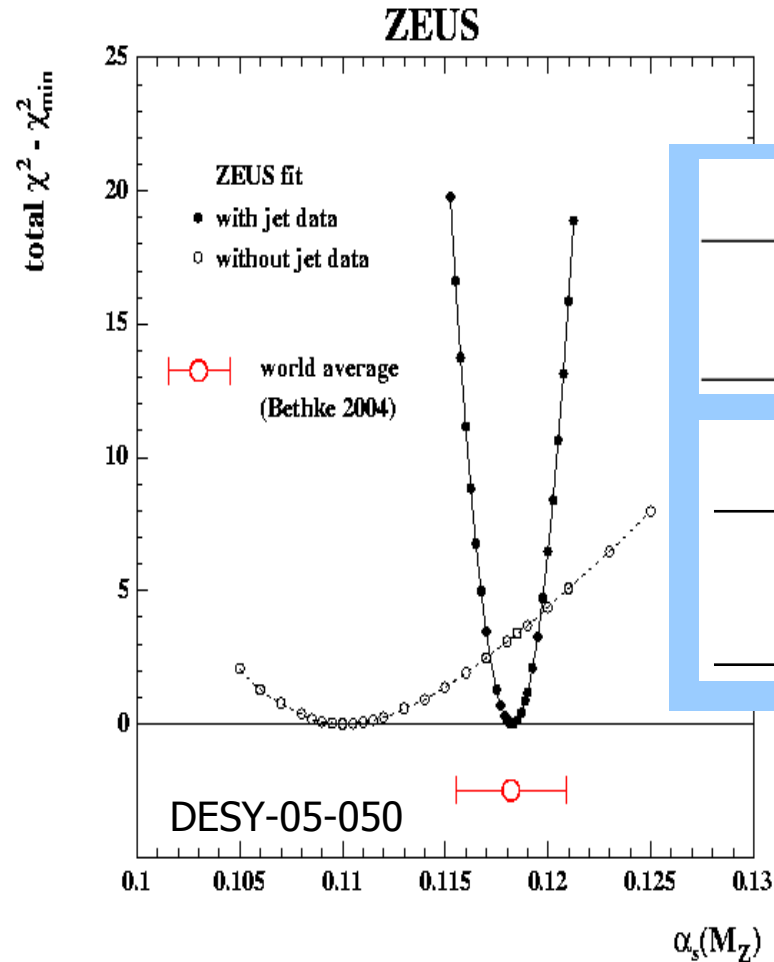
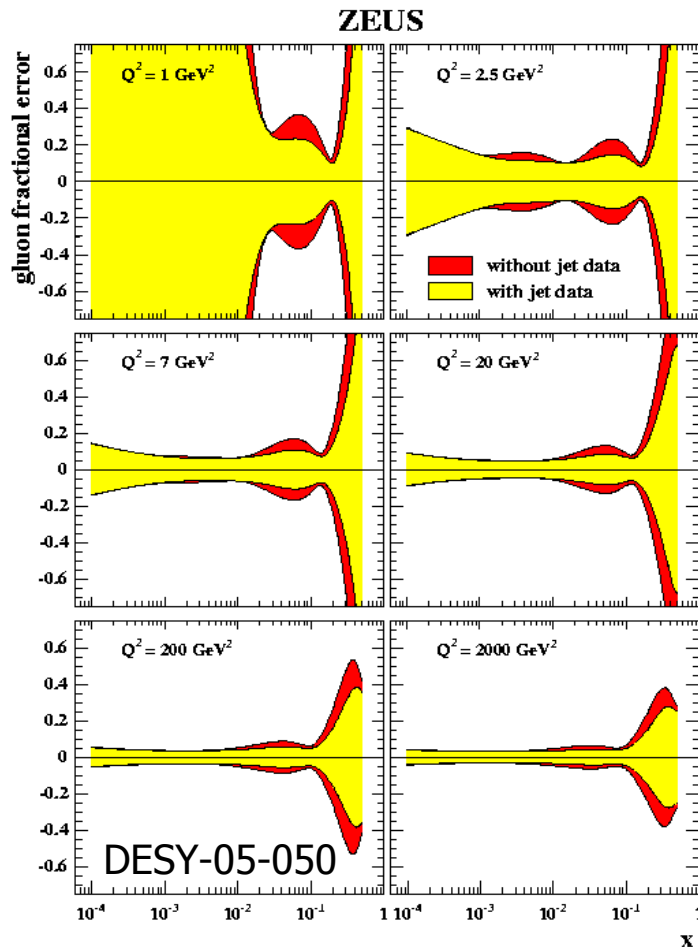

Large effect on gluon density at medium / high x – even with limited HERA1 data.

Great improvement of value and error!
Problem: Correlation of $xg(x)$ and α_s .

FROM PHOTOPRODUCTION TO DIS



The regime of low Q^2 (and low x)

- For $E_T^2 > Q^2$ parton "resolves" hadronic photon structure

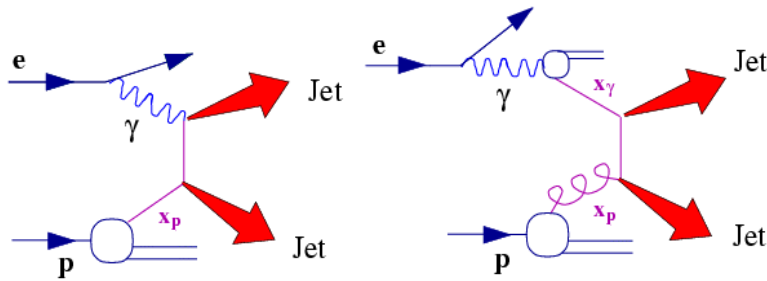

$x_\gamma = 1$
"direct"

$x_\gamma < 1$
"resolved"

- ZEUS (DESY-04-053): Quantify amount of resolved photon as function of Q^2 , E_T !

- γp NLO fine; MC+PS+resolved okay!
- Resolved relevant for $Q^2 > 100 \text{ GeV}^2$. Question of renormalization scale?

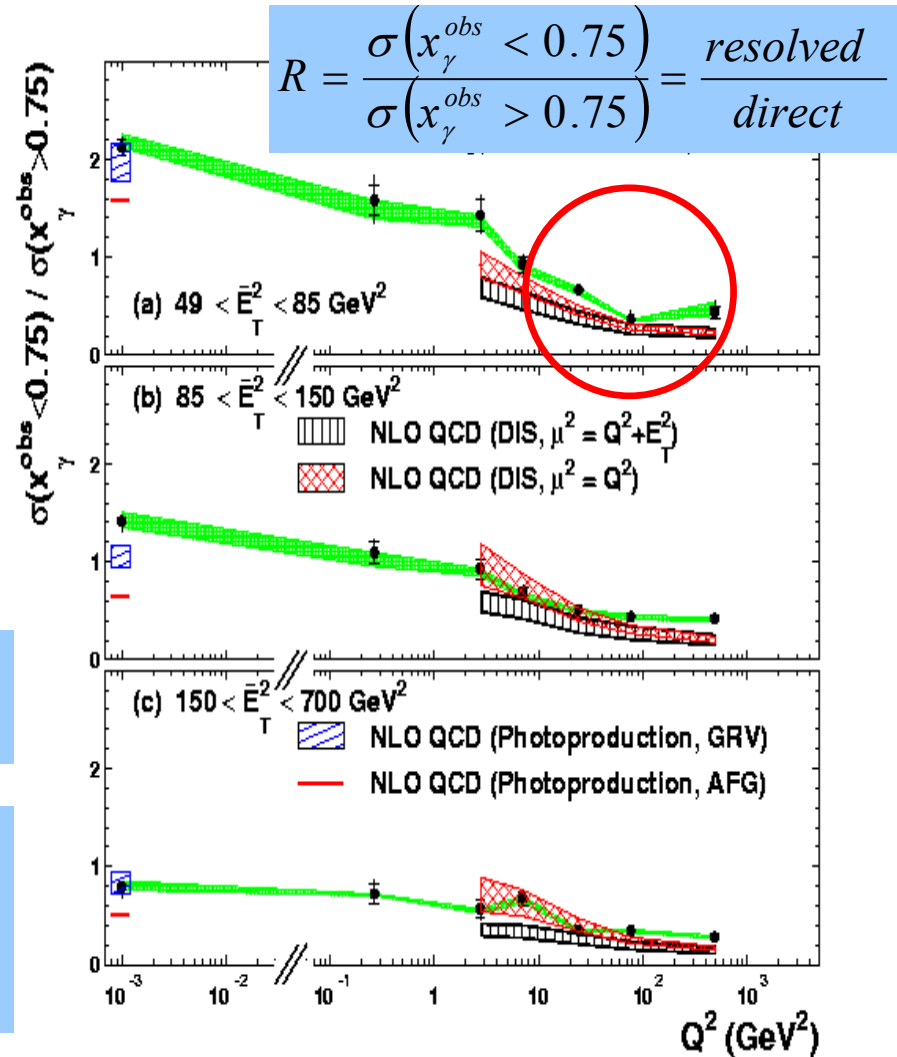

FROM PHOTOPRODUCTION TO DIS



The regime of low Q^2 (and low x)

- **H1 triple-differential cross-section in x , Q^2 and p_t**

- DESY-03-206)
 - $2 < Q^2 < 80 \text{ GeV}^2$.

- Study interplay of Q^2 and E_T^* (**photon PDF \leftrightarrow proton PDF**)

- **Direct AND resolved NLO QCD not enough at low x_γ .**

- In LO MC (HERWIG) need parton shower, direct and resolved photons (longitudinal and transverse polarization).

- CASCADE (CCFM) without k_T -ordering best at medium Q^2 (does it mimic resolved?)

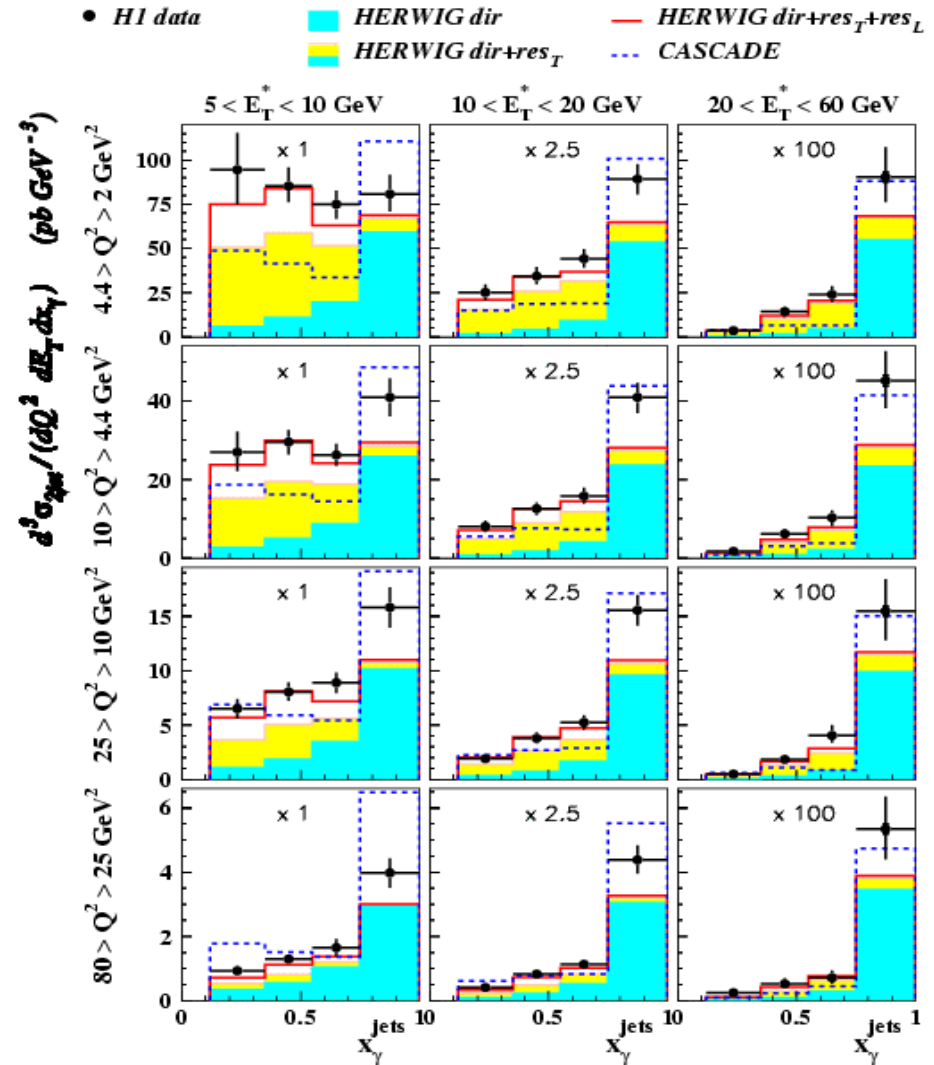

PHOTOPRODUCTION JETS



Sensitivity to the photon's PDFs?

- **ZEUS dijet measurement in photoproduction:**

Cross-sections as functions of x_γ in 39pb^{-1} from 1996/97

- For high x_γ (direct!) NLO QCD fine \rightarrow cross-check of gluon as extracted from DIS analyses.

- At low x_γ and for low $E_{T^{\text{jet}}}$: **sensitive to γ structure!**
But difficult to exploit!
(see next slide)

HERA dijet photoproduction

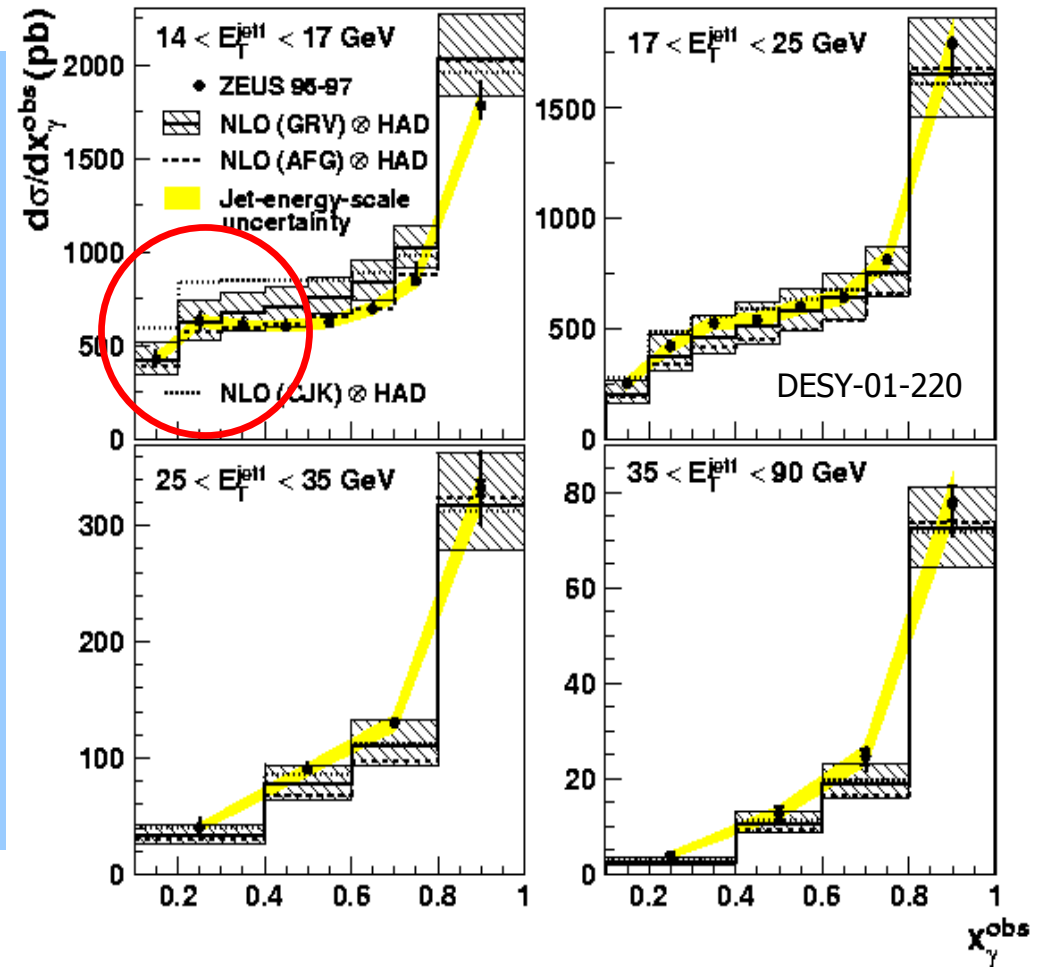

JETS AND PHOTON STRUCTURE



Low E_T jets and the photon's PDFs

- Low E_T jets (4/6 GeV) sensitive to gluon content in photon.

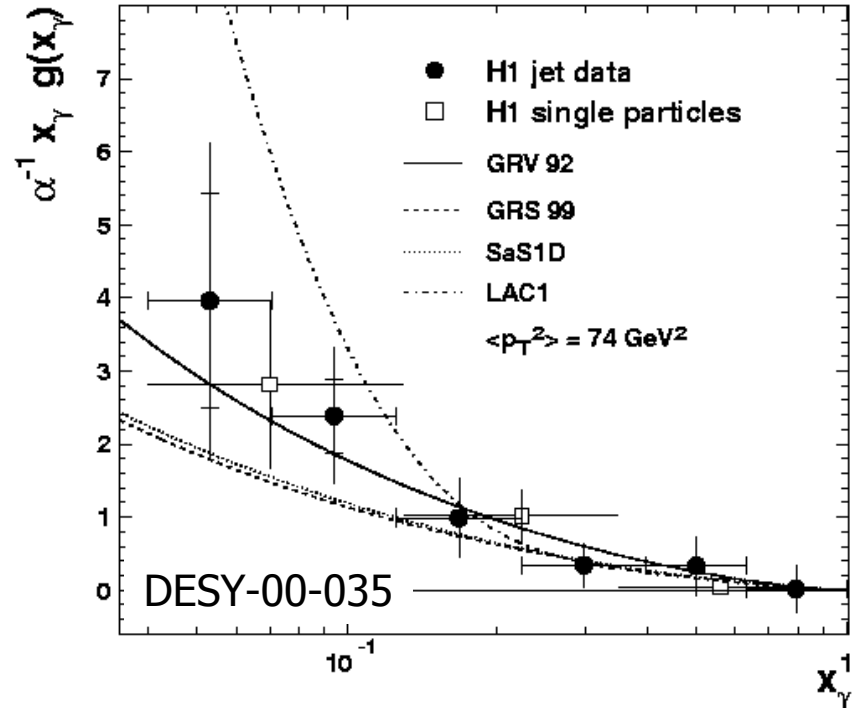
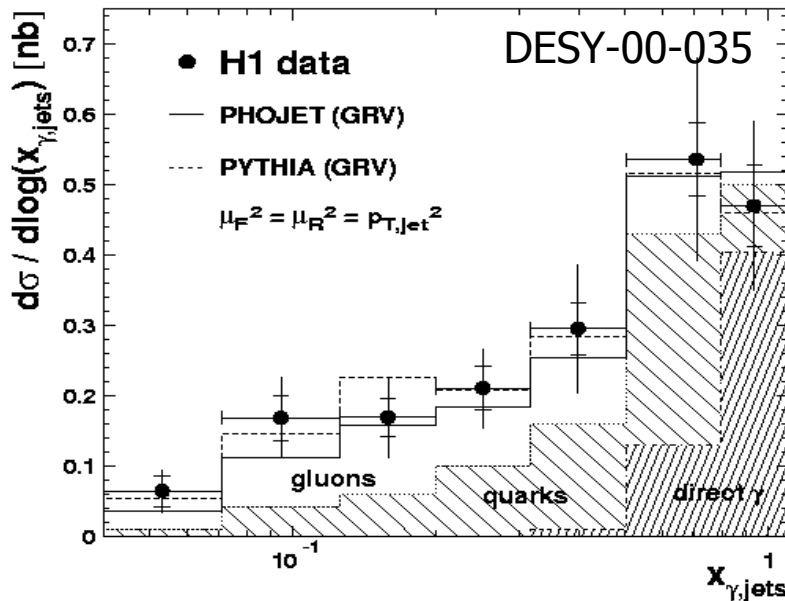

- Large contributions from underlying events for low E_T values
 → subtraction procedure.
- Size of correction depends on model!
 → large uncertainties!

Gluon density in the photon from H1 dijet data in photoproduction:

Agreement with other determinations; but very large errors.

FORWARD JETS

Hunting for signs of BFKL evolution

- **DGLAP approximation: Resum terms $\ln Q^2$ for parton evolution**
 → works very well for most of HERA regime (F_2 !)
- **breakdown expected at very low x since terms $\ln 1/x$ neglected!**
 -- can we distinguish the onset of BFKL-like evolution?
 → “forward / Mueller-Navelet jets”
 → CCFM evolution as a bridge between DGLAP and BFKL?

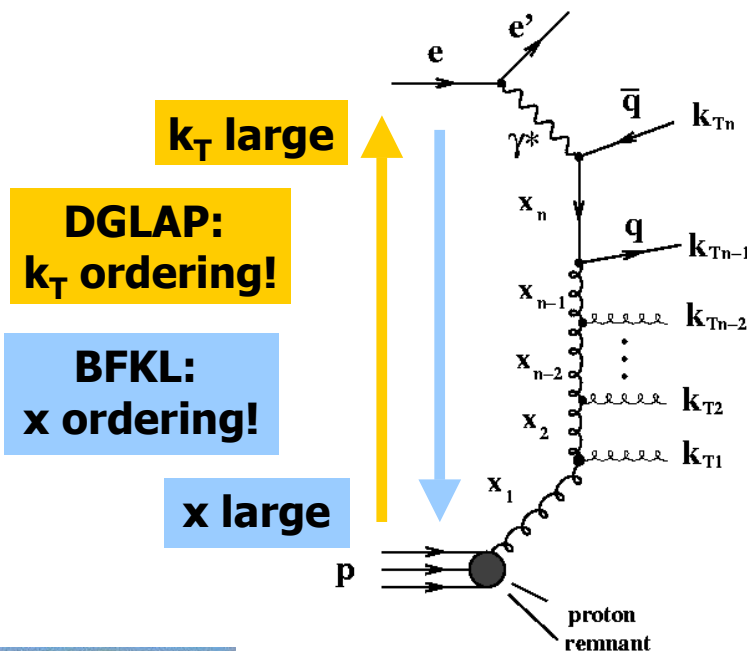

Design phase-space to suppress DGLAP and enhance BFKL:

- forward region: $\eta > 2$ (close to proton)
- jet $E_T^2 \sim Q^2$ (suppressed in DGLAP)
- large $x_{\text{jet}} = E_{\text{jet}}/E_{\text{proton}}$ (realized in BFKL)

**All results: Problems at low x !
 NNLO? Resolved? Evolution?**

H1 AND ZEUS FORWARD JETS



as functions of x – spot problems in evolution?

- only 1997 data, 13.7pb^{-1}
- $5 < Q^2 < 85 \text{ GeV}^2$, $\mu_R = E_T$

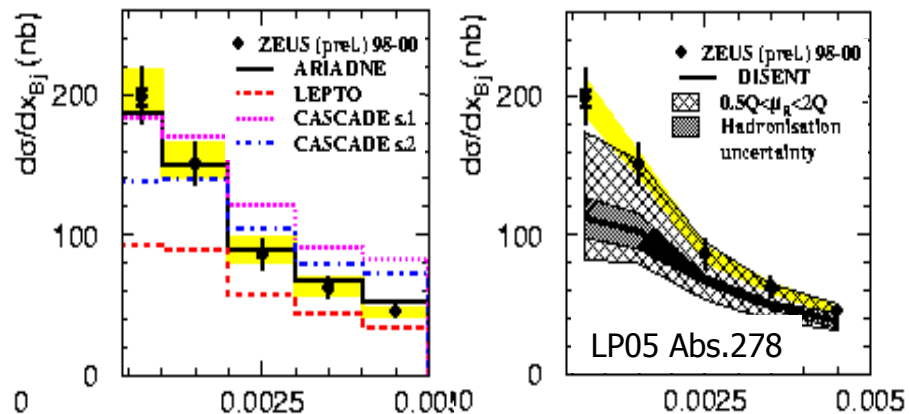
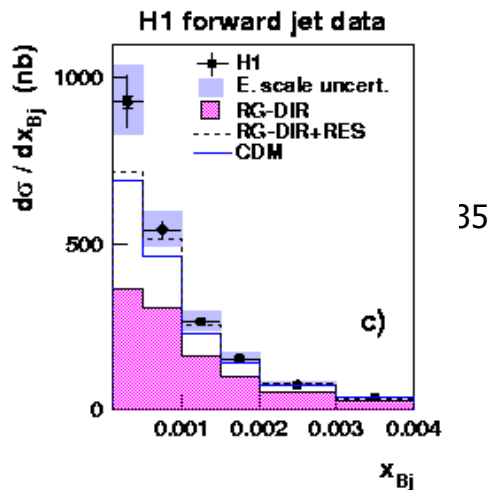
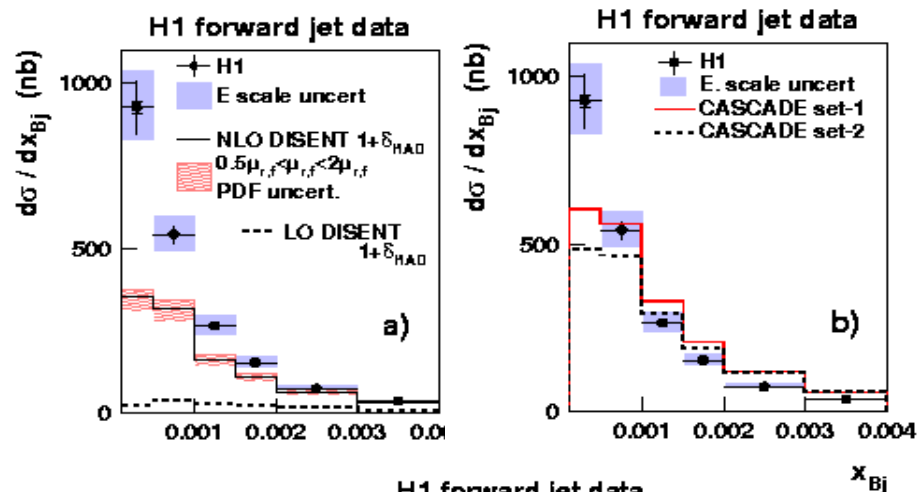

Tighter cuts than H1 \rightarrow same statistics from 72pb^{-1} . $\mu_R = Q$.

All models below data at low x .

- CCFM unclear (PDFs, missing $g \rightarrow qq$ terms?)
- resolved photons better
- ARIADNE (BFKL-like) good

CONCLUSION: UNCLEAR!

FORWARD JET+CENTRAL DIJETS



Further constraining the phase-space (H1)

Request dijets in central detector

(same $E_T > 6$ GeV for all jets \rightarrow
no k_T -ordering \rightarrow DGLAP suppressed):

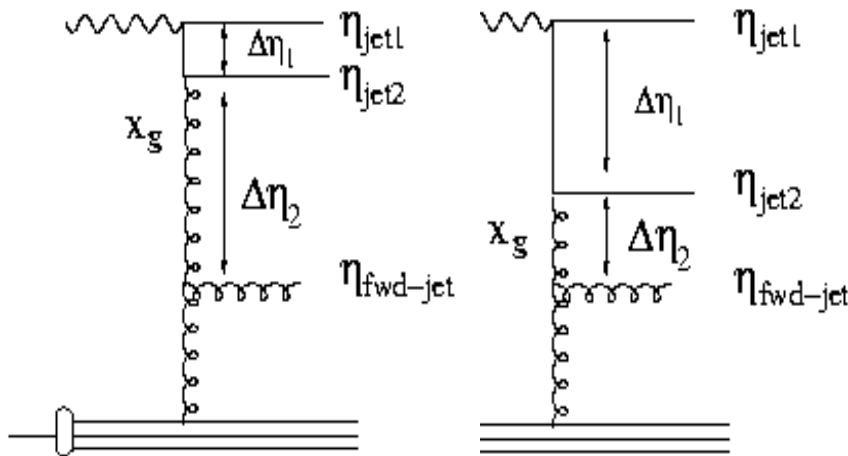

Choice of $\Delta\eta_1, \Delta\eta_2$ selects specific evolution scenarios:

- $\Delta\eta_2$ small \rightarrow no PS for BFKL radiation
- $\Delta\eta_1$ large \rightarrow BFKL between jet1, jet2?
- 'BFKL' region: $\Delta\eta_1 < 1, \Delta\eta_2 > 1$
- But: correct ordering of jets?

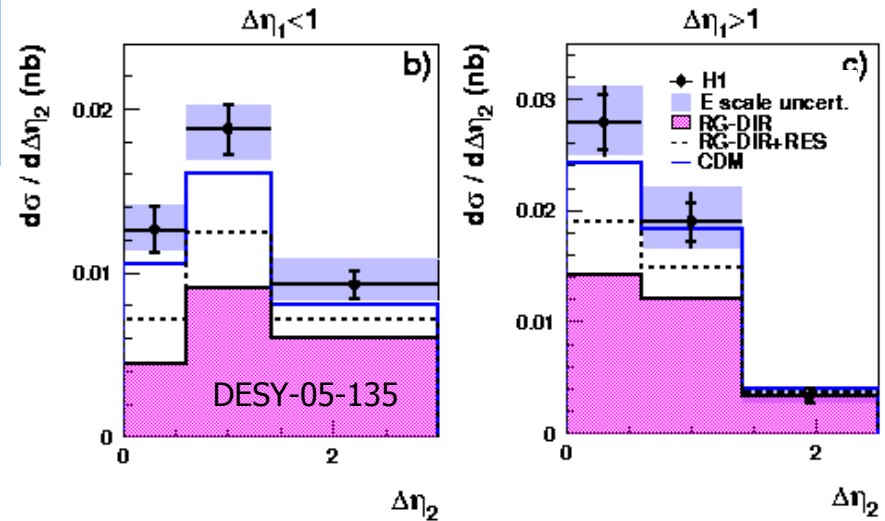

- resolved LO MC fails!
- CDM (BFKL-like) close to data
- CCFM does not describe shapes.

CONCLUSION: UNCLEAR!

But clearly more k_T -unordered necessary than in resolved γ .

SUMMARY AND OUTLOOK



Jet physics at HERA delivers many nice results!

- **Many measurements and QCD tests performed with jets. Interesting areas (transition DIS-photoproduction, forward jets)**
 - Detailed Xsections and α_s measurements make HERA a precision QCD machine (QCD fits); input crucial for LHC physics (QCD background).
 - Many analyses contributing to better understanding of QCD fundamentals!

- **Many measurements dominated by theoretical uncertainties; progress relies especially on theoretical advancements:**
 - NNLO: splitting functions already available!
Effect: More reliable cross-section prediction, reduction of scale uncertainty
 - MC@NLO program (S. Frixione) with NLO matrix elements and parton showers attached already implemented for pp; work on ep has started.
Effect: Simultaneous description of small-angle and large-angle phenomena; reliable estimates of hadronisation corrections

- **HERA lumi aim until 31/07/2007: 700pb⁻¹; 10× HERA1 statistics!**
 - Improve existing measurements and stay open for the unexpected!

NOT COVERED IN THIS TALK



Too many interesting subjects! _____

- Subjet measurements in photoproduction (ZEUS) → QCD radiation pattern
- QCD color structure analysis using three-jet angular correlations (ZEUS)
- Interjet energy flow and the question of high- p_T color-singlet exchange (ZEUS)
- Event and jet shapes.
- Forward neutral pions (same questions as for forward jets).
- More results on the hadronic final state (multiplicities etc.).
- ...



BACKUP SLIDES

EXPERIMENTAL ENVIRONMENT



HERA, H1 and ZEUS

- p(920 GeV) on e(27.5 GeV)
- CMS energy: 318 GeV
- H1 and ZEUS: ~400 physicists

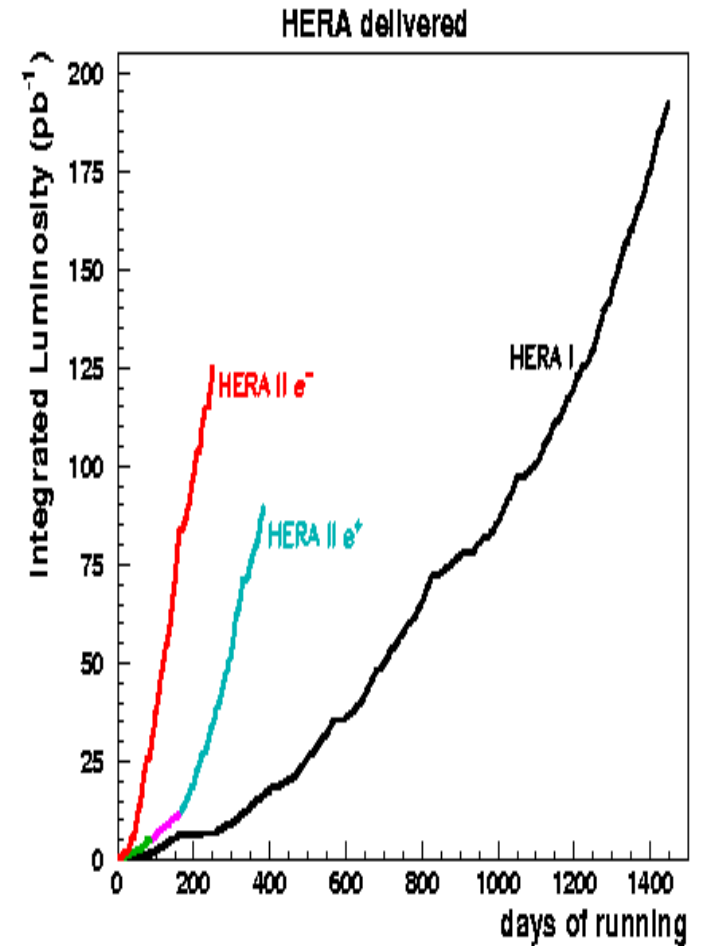
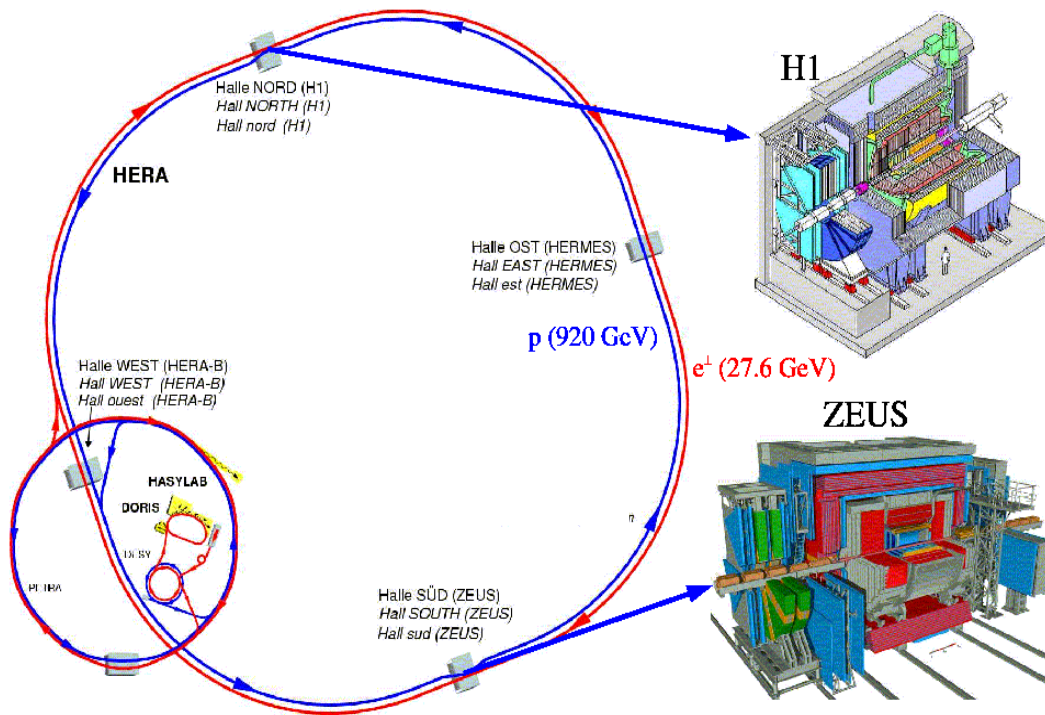

MOTIVATION AND OUTLINE



... from "simple" to more and more complex

Cross-section measurements

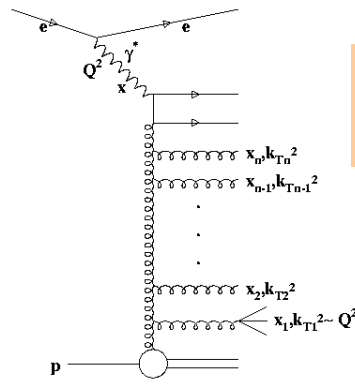
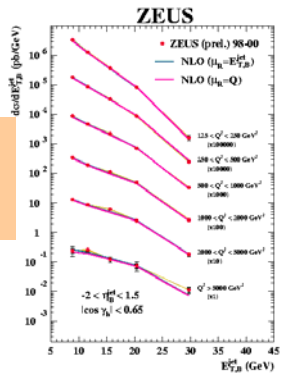

Forward jets and parton evolution

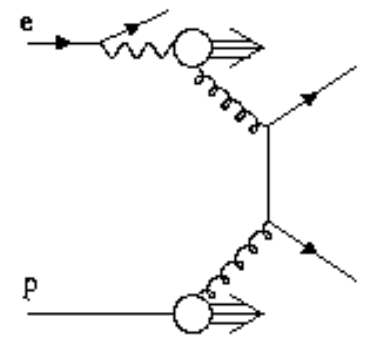
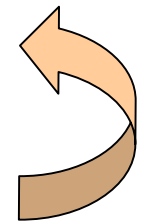

Jets at low Q^2, x

Extraction of QCD parameters

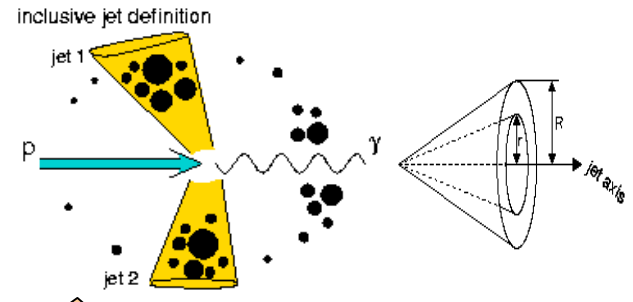
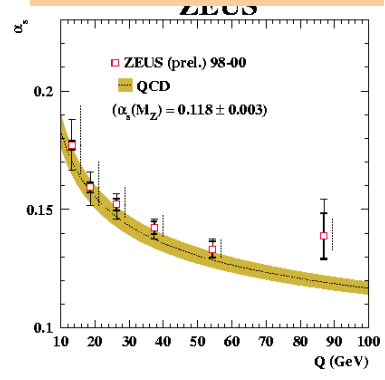

More fun with jets

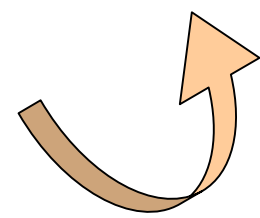

I will mainly concentrate on new results since ICHEP04.

EXPERIMENTAL ENVIRONMENT



HERA, H1 and ZEUS, kinematics of ep physics

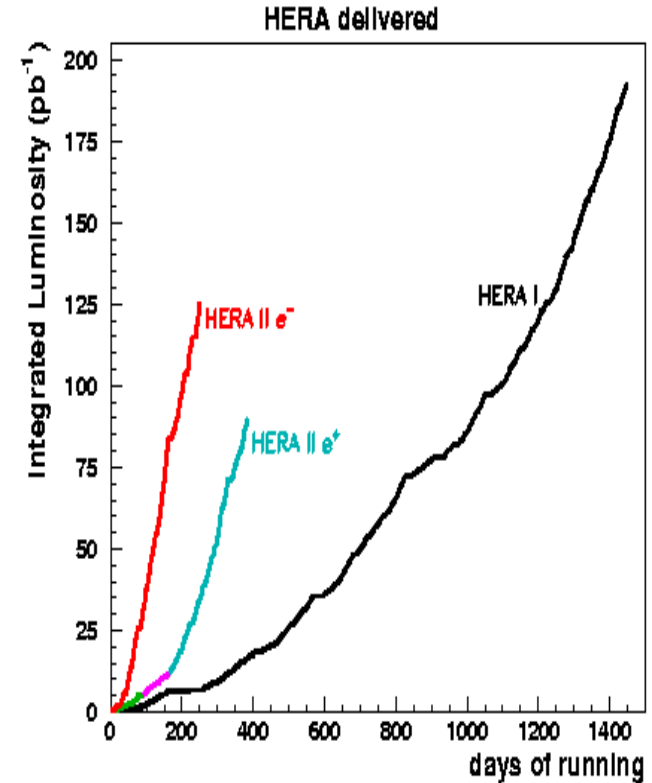
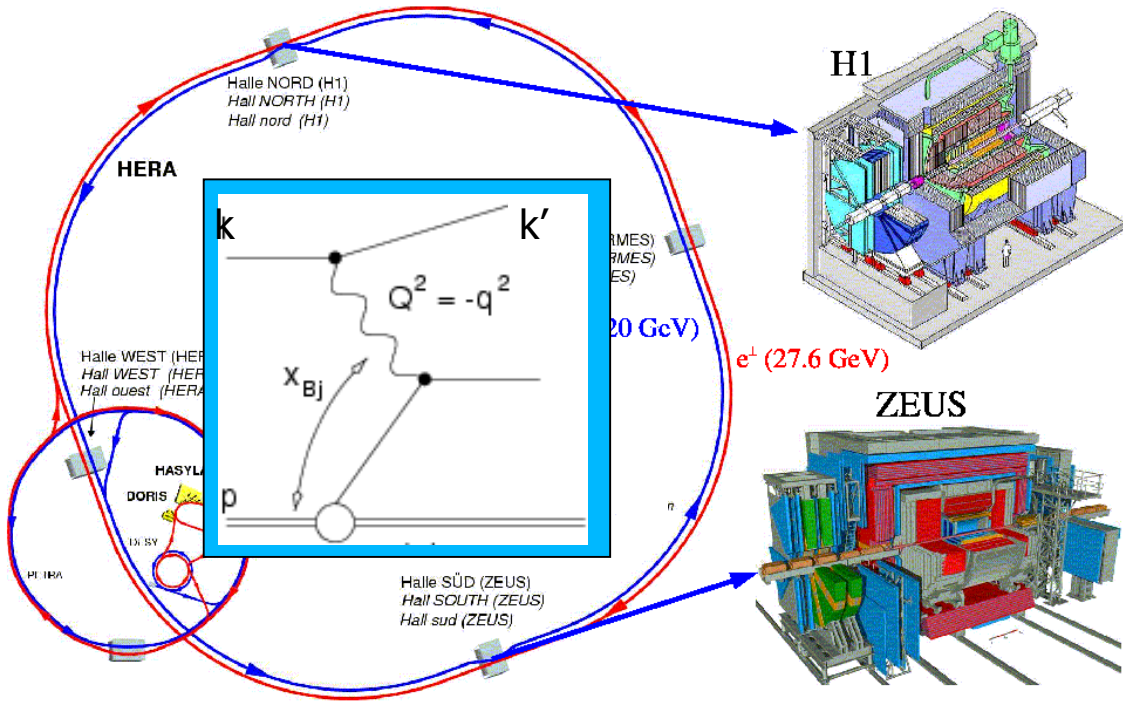

Momentum transfer

$$Q^2 = -(k - k')^2$$

Proton momentum fraction in scattering

$$x = \frac{Q^2}{2Pq}$$

Energy transfer

$$y = 1 - \frac{E'}{E}$$

At given CMS energy only two kin. variables independent:

$$Q^2 = xys$$

Lumi summary:

- HERA-I (ZEUS): 91.7 pb^{-1}
- HERA-II (e^+) : 40.6 pb^{-1}
- HERA-II (e^-) : $\sim 100 \text{ pb}^{-1}$

INCLUSIVE, 2, 3 JETS AT HIGH Q^2



Well understood phase-space: $Q^2 > 125 \text{ GeV}^2$, $E_{T,\text{jet}} > 8 \text{ GeV}$

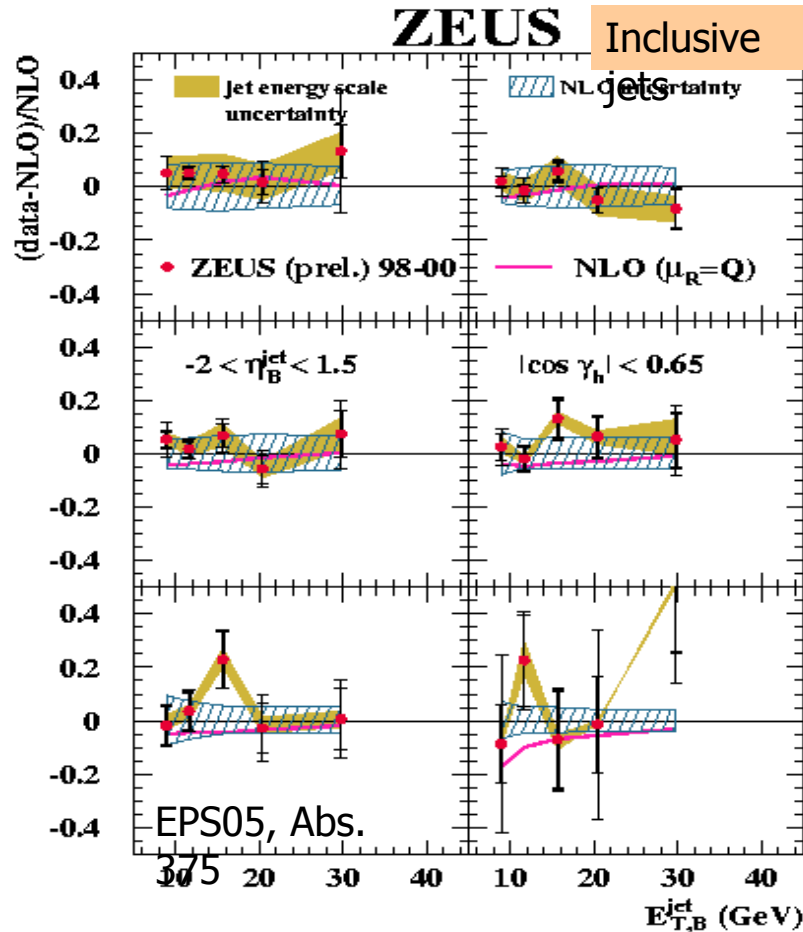

Excellent description of data by NLO QCD calculations.

2 JETS IN PHOTOPRODUCTION (H1)

Further constraining the gluon in the proton

- 67pb-1, 99/00
- $Q^2 < 1 \text{ GeV}^2, 0.1 < y < 0.9$
- $p_{T1,2} > 25, 15 \text{ GeV}$ (asymmetric cut \rightarrow safe NLO region)
- Results compared to LO MC and NLO calculations.

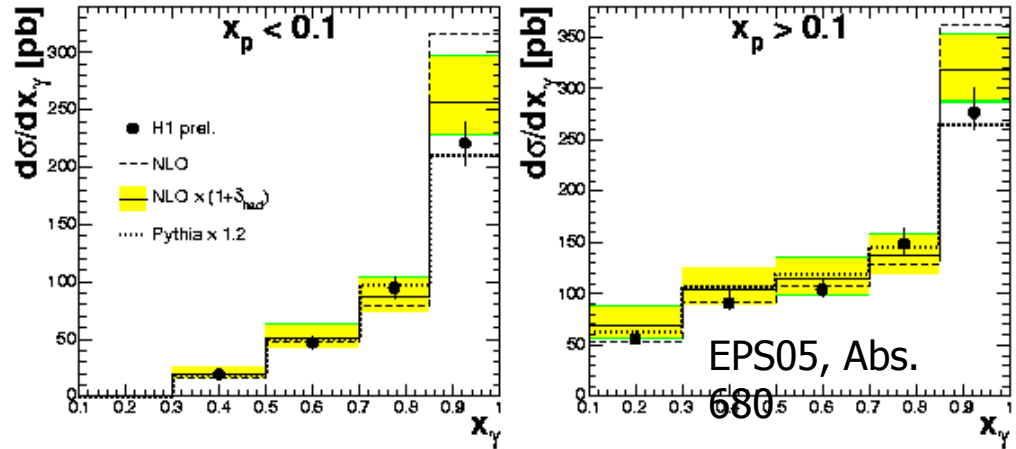

Special emphasis on x_γ and x_p (momentum fractions of photon and proton participating in the interactions \rightarrow learn something about PDFs, especially $xg(x)$?)

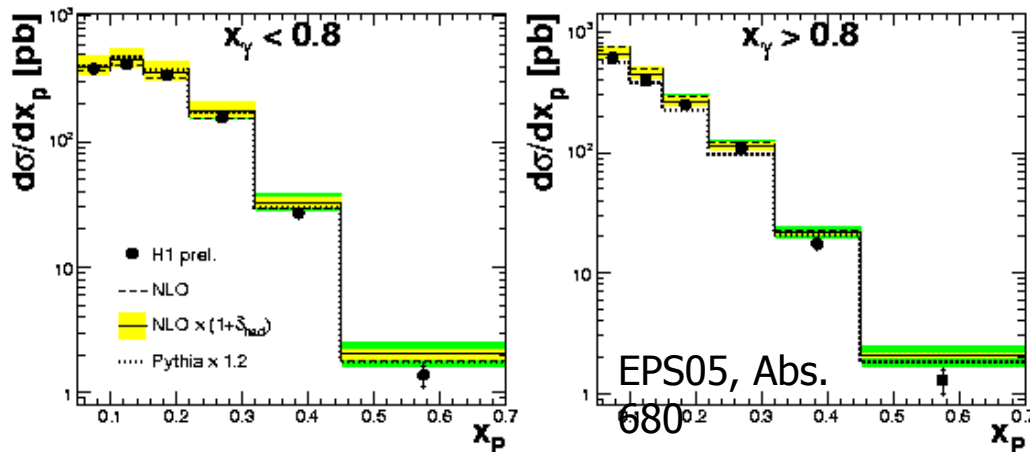

Good description of data over wide kinematic range by both the MC and the NLO calculation.

Use direct part of these data in PDF fit (as done by ZEUS - see later?)

α_s FROM JETS AT HIGH Q^2 : H1



Results

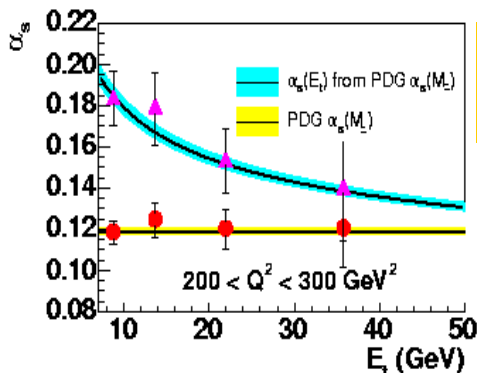
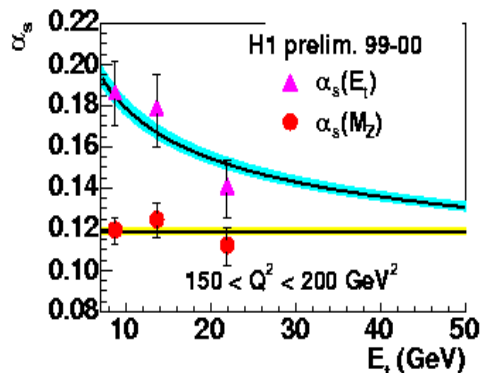

15 data points in χ^2 fit with $\chi^2/\text{dof} = 1.44$

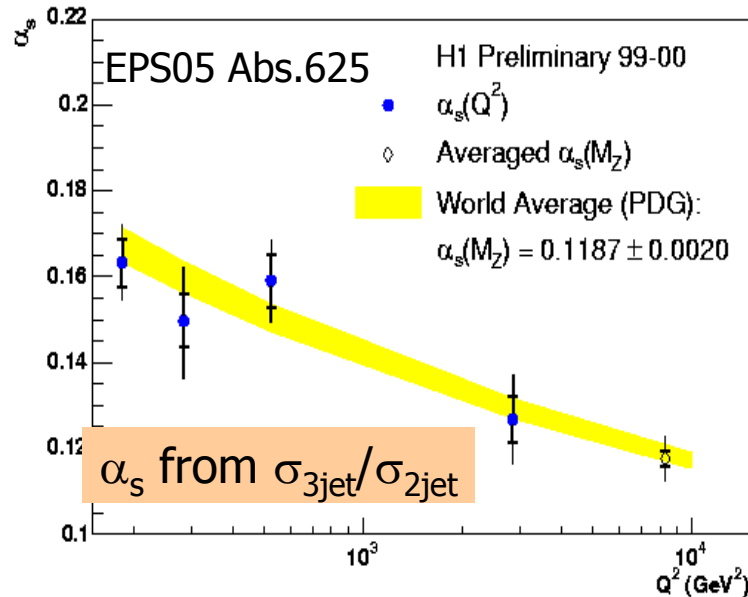
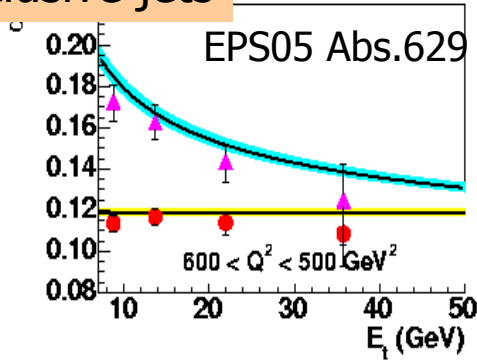
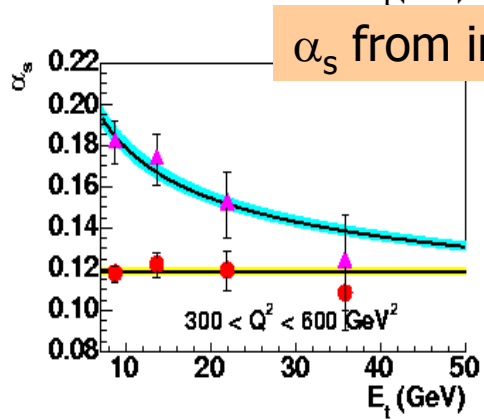

World average: $\alpha_s(M_Z) = 0.1187 \pm 0.0020$
 H1 inclusive jets: $\alpha_s(M_Z) = 0.1197 \pm 0.0016(\text{exp}) \pm 0.0047(\text{theo})$
 H1 3/2jet ratio: $\alpha_s(M_Z) = 0.1175 \pm 0.0053(\text{exp}) \pm 0.0061(\text{theo})$

Very nice agreement!
 Errors coming down!

α_s FROM JETS AT HIGH Q^2 : ZEUS



Results

α_s from ratio $\sigma_{3\text{jet}}/\sigma_{2\text{jet}} \rightarrow$
some uncertainties cancel out!

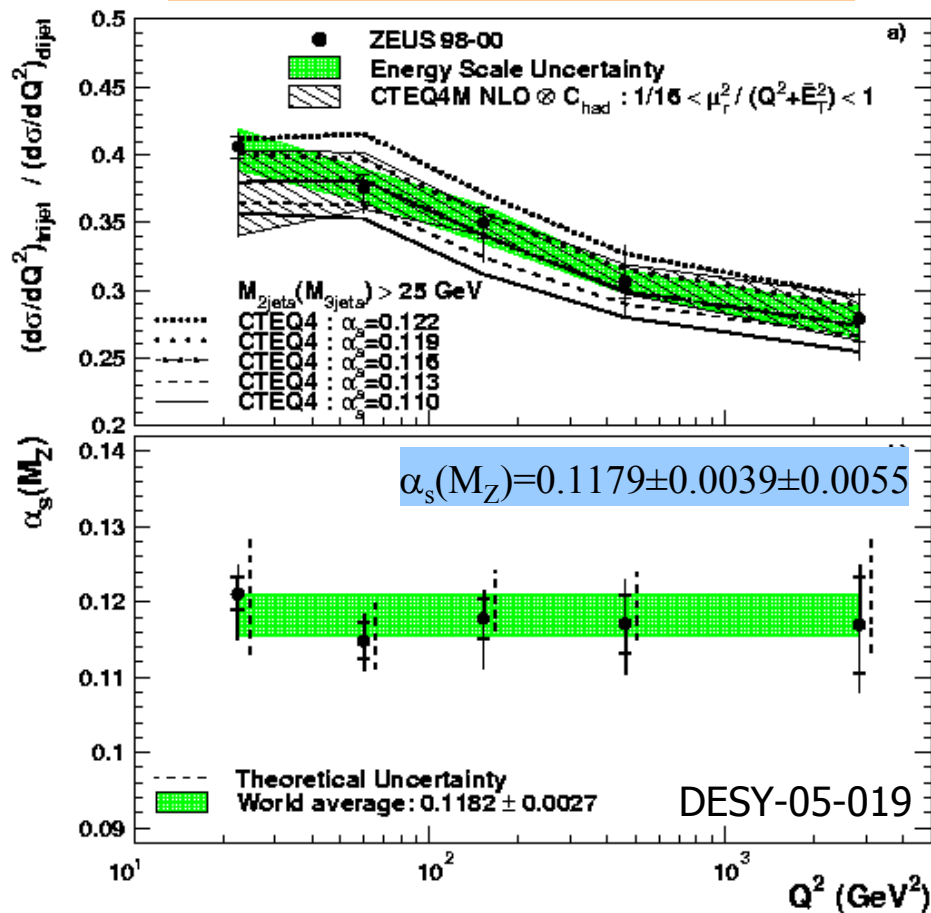

α_s from inclusive jets:
small theoretical uncertainty!

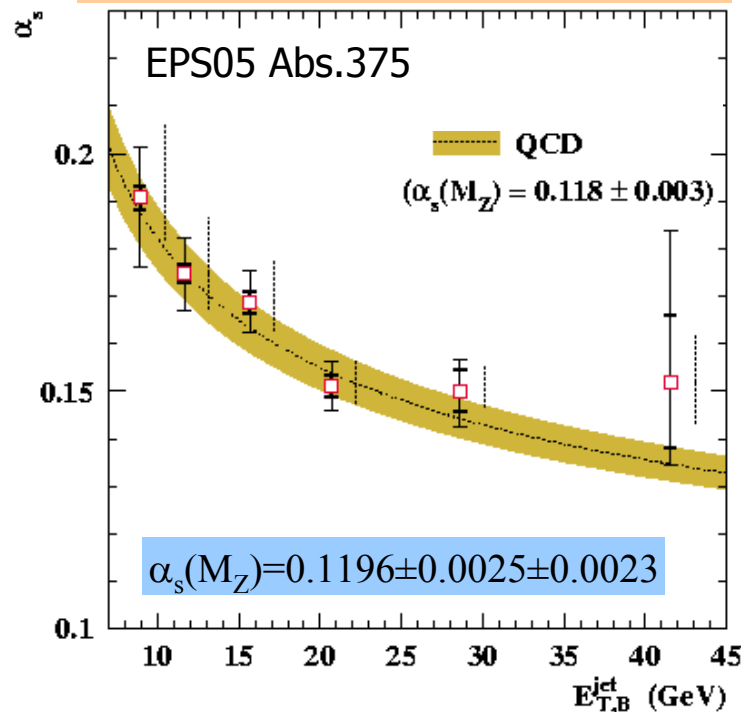

GLOBAL QCD FITS AND α_s



Effect on gluon uncertainty

Strong correlation between α_s and the gluon density for inclusive F_2 data

→ large increase in gluon uncertainty when α_s free!

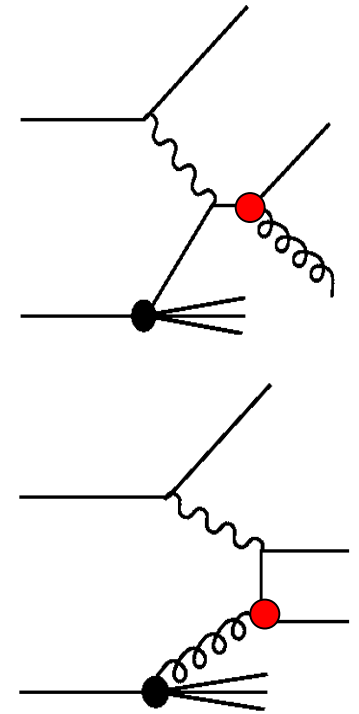
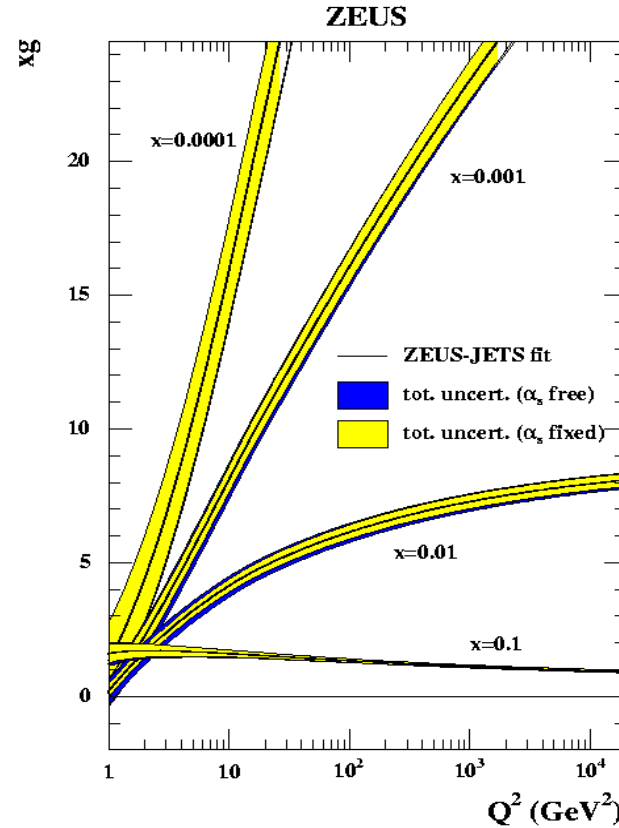
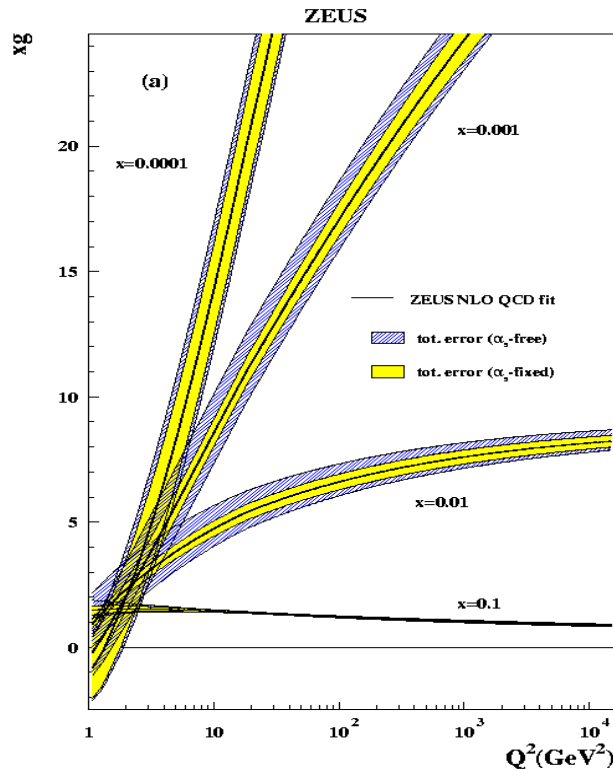

Jet cross sections directly sensitive to α_s via $\gamma^*g \rightarrow qq\bar{q}$ (coupled to gluon) and via $\gamma^*q \rightarrow qg$ (NOT coupled to gluon)

→ α_s NOT as strongly correlated to gluon

SUBJET DISTRIBUTIONS



in high- Q^2 DIS – study QCD radiation pattern / jet structure

- Subjets are resolved by applying k_{\perp} algo to objects of one jet as function of distance measure $d_{\text{cut}} = y_{\text{cut}} \cdot E_T^2$. Chosen here: Jets with two subjets at $y_{\text{cut}} = 0.05$!

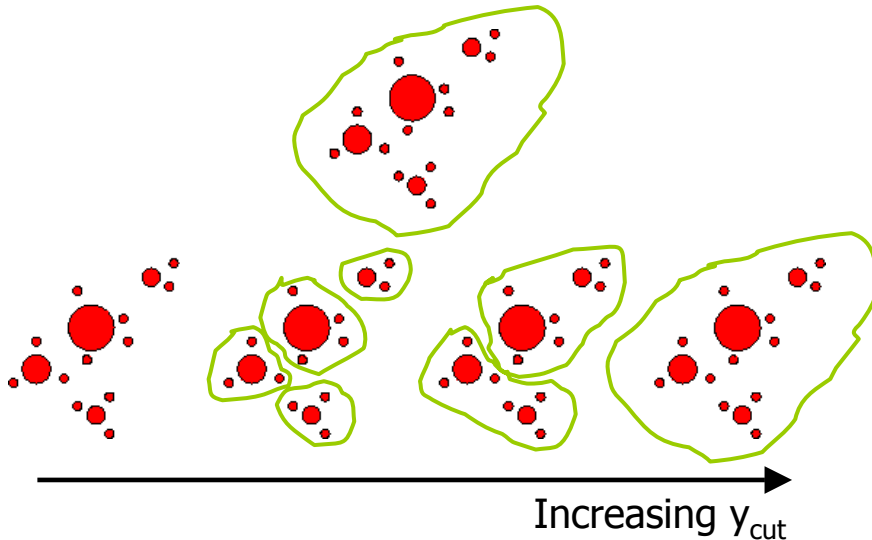

- Basically tested variables $E_{T,\text{sub}}/E_{T,\text{jet}}$, $\eta^{\text{sub}} - \eta^{\text{jet}}$, $|\phi^{\text{sub}} - \phi^{\text{jet}}|$ and orientation of subjets in η - ϕ space with respect to proton beam.

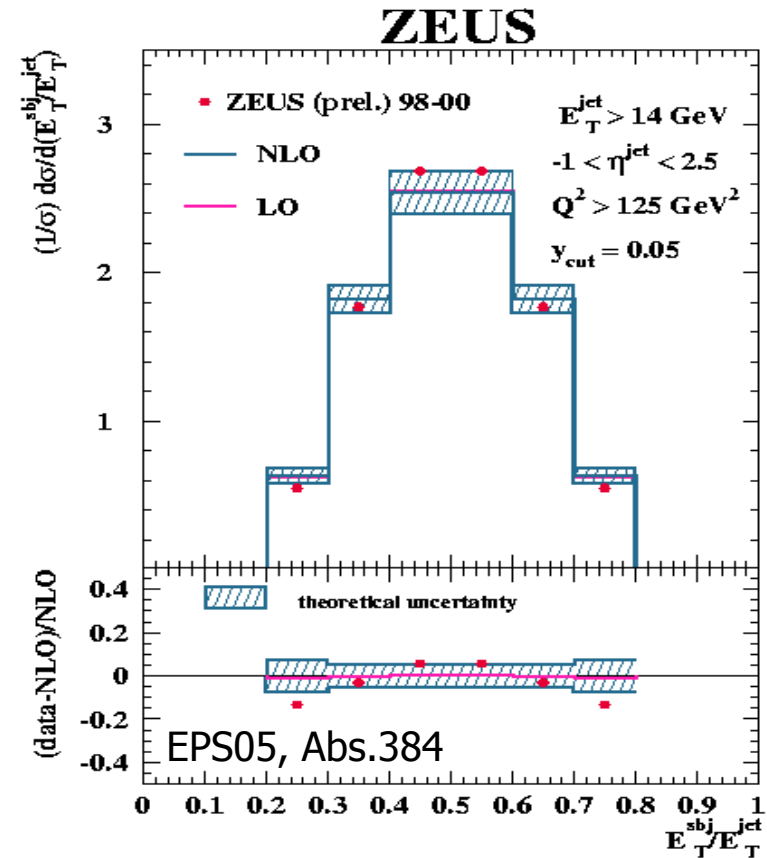

- All distributions nicely described by NLO QCD within 10%.

QCD COLOR DYNAMICS



3-Jet angular correlations and the underlying gauge group

Aim: Investigate color dynamics and underlying gauge group using color factors C_F , C_A , and T_F of QCD.

The 3jet Xsection is sensitive to various color factor combinations:

$$\sigma_{ep \rightarrow 3 jets} = C_F^2 \cdot \sigma_A + C_F C_A \cdot \sigma_B + C_F T_F \cdot \sigma_C + T_F C_A \cdot \sigma_D$$

α_{23} : angle between two lowest-energy jets in 3-jet events!

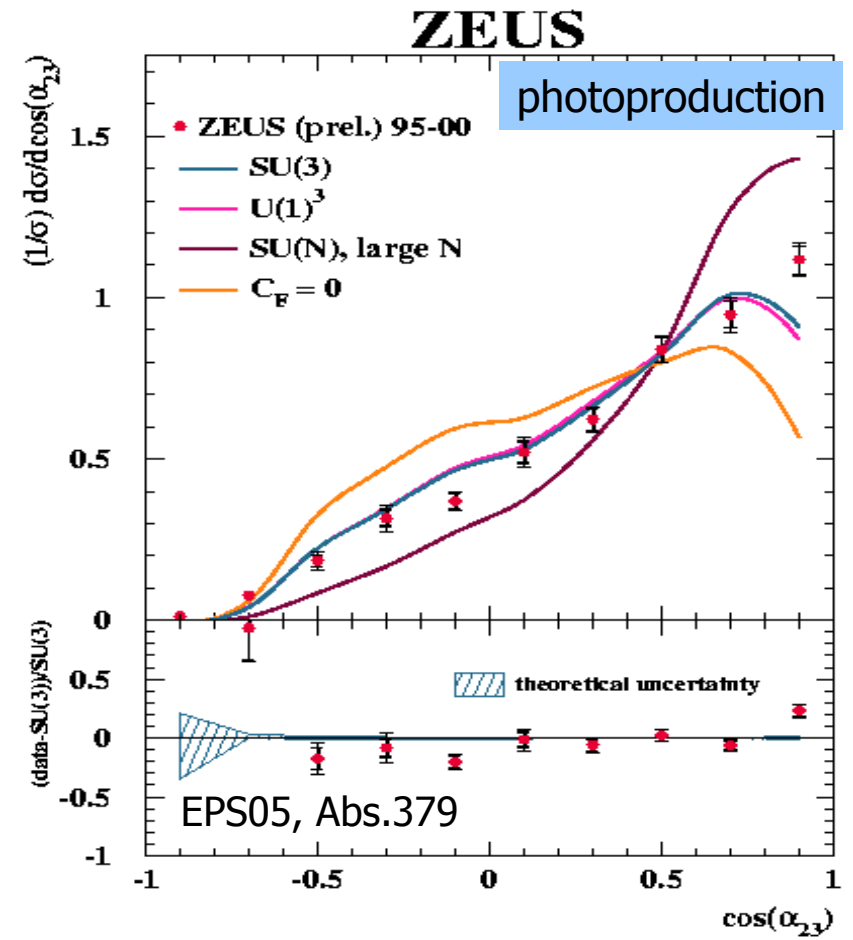
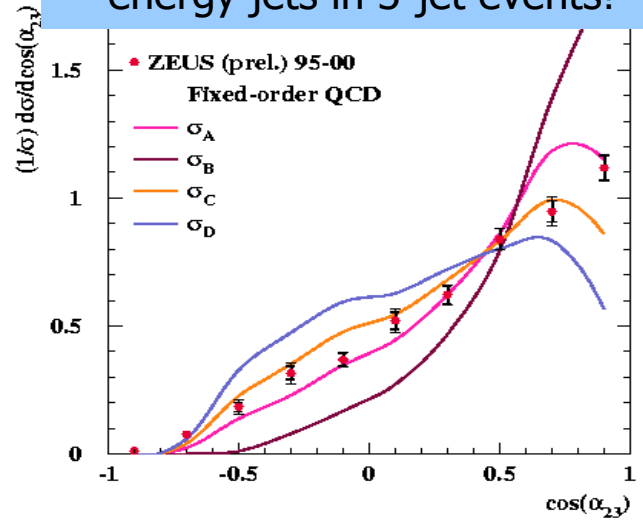

SU(3) favoured, but U(1)³ not excluded!
CF=0 and SU(N) (N large) excluded!

QCD COLOR DYNAMICS



3-Jet angular correlations and the underlying gauge group

Aim: Investigate color dynamics and underlying gauge group using color factors C_F , C_A , and T_F of QCD.

At LO 3jet Xsection sensitive to various color factor combinations:

$$\sigma_{ep \rightarrow 3 \text{ jets}} = C_F^2 \cdot \sigma_A + C_F C_A \cdot \sigma_B + C_F T_F \cdot \sigma_C + T_F C_A \cdot \sigma_D$$

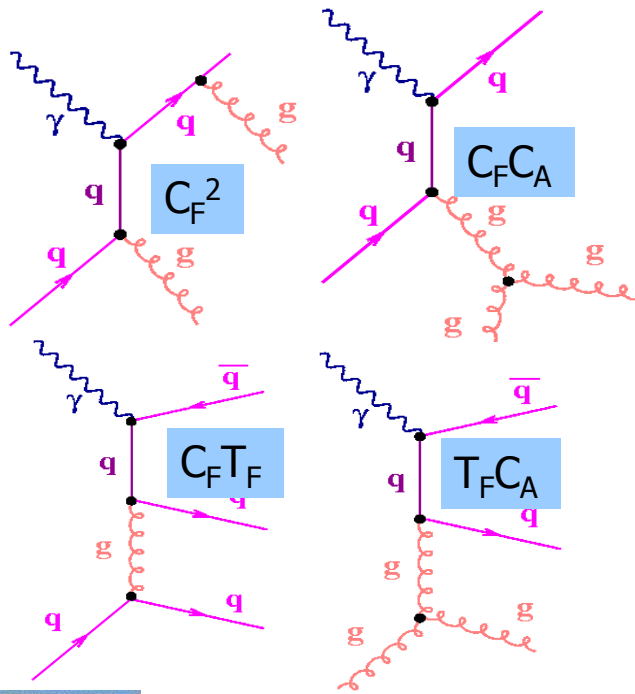

α_{23} : angle between two lowest-energy jets in 3-jet events!

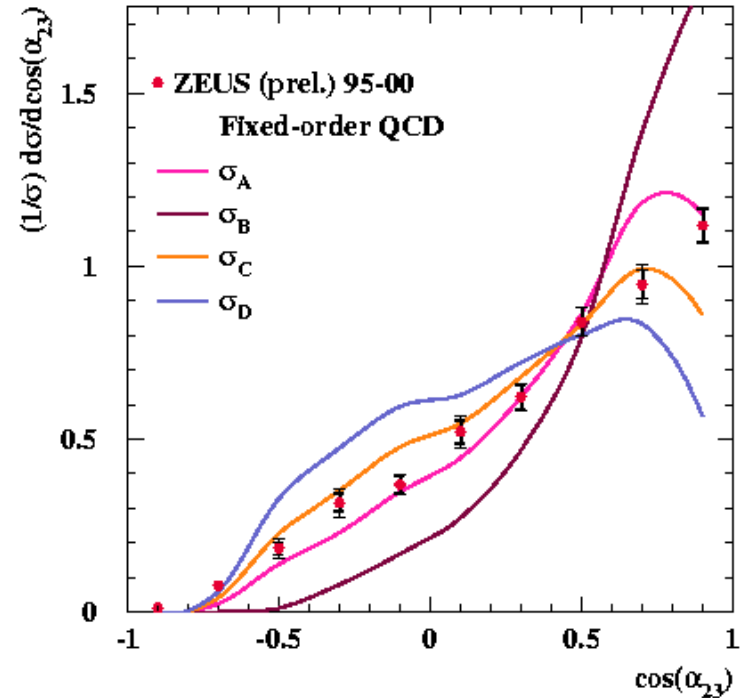

Sensitivity to different contributions!

QCD COLOR DYNAMICS



3-Jet angular correlations and the underlying gauge group

ZEUS

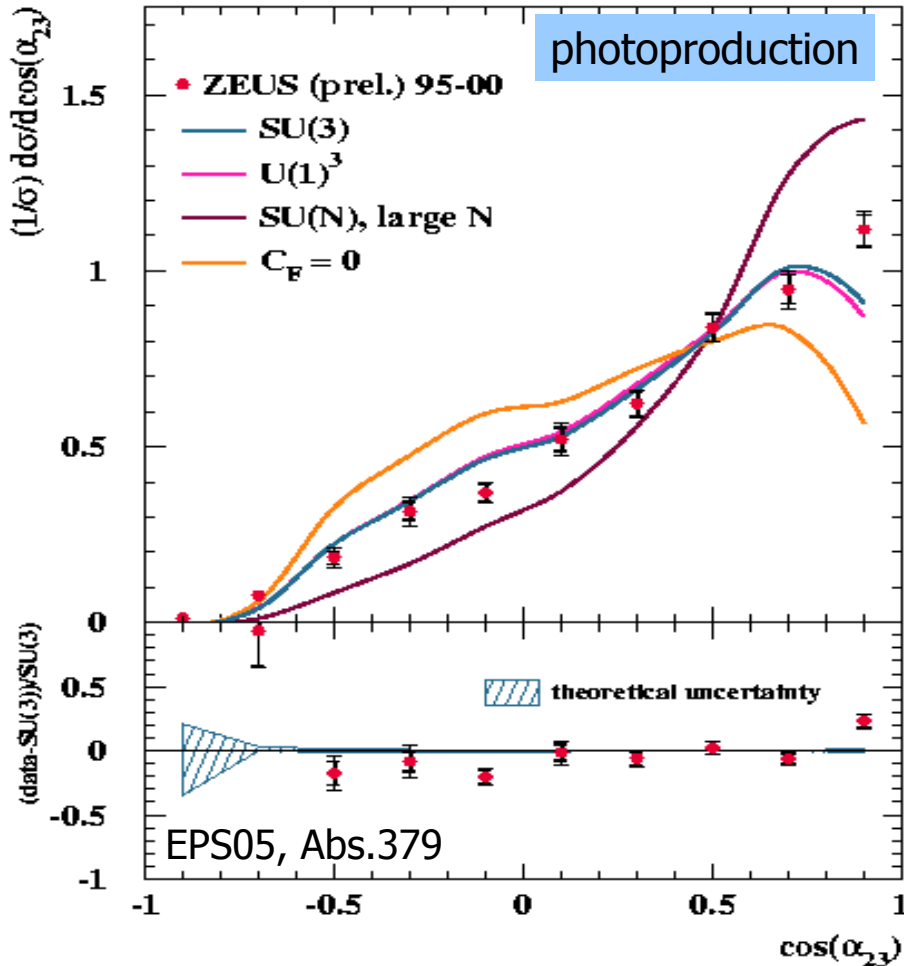

ZEUS

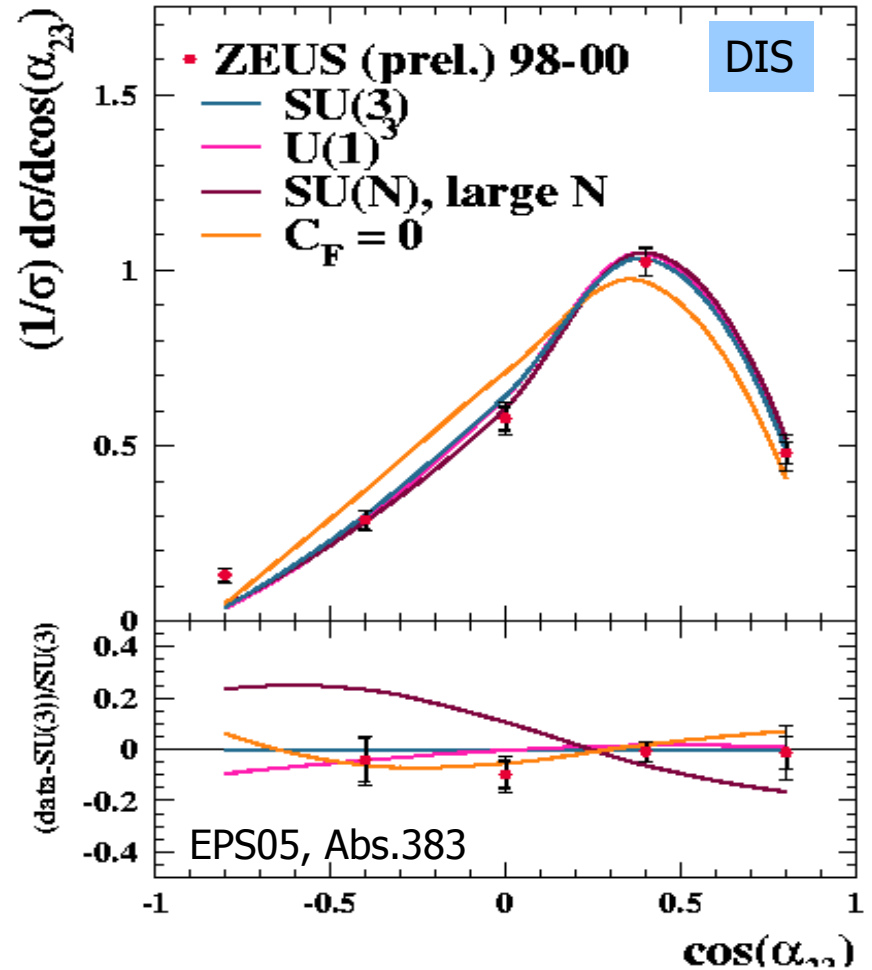

SU(3) favoured, but U(1)³ not excluded!

C_F=0 excluded!

INTERJET ENERGY FLOW

in photoproduction dijet events with large rapidity gap

- Study color-singlet exchange with large momentum transfer by looking for rapidity gap dijet events.

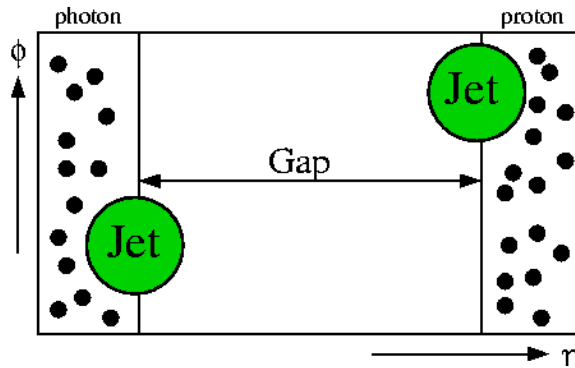
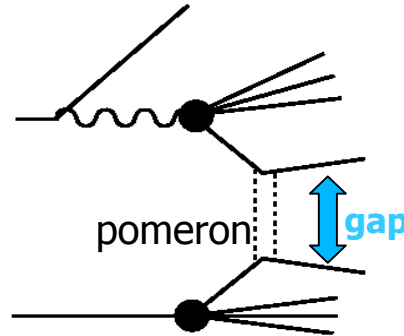

- Compare data to MC models with(out) CS contribution:
 - PYTHIA: high- t - γ exchange;
 - Herwig: BFKL-Pomeron.

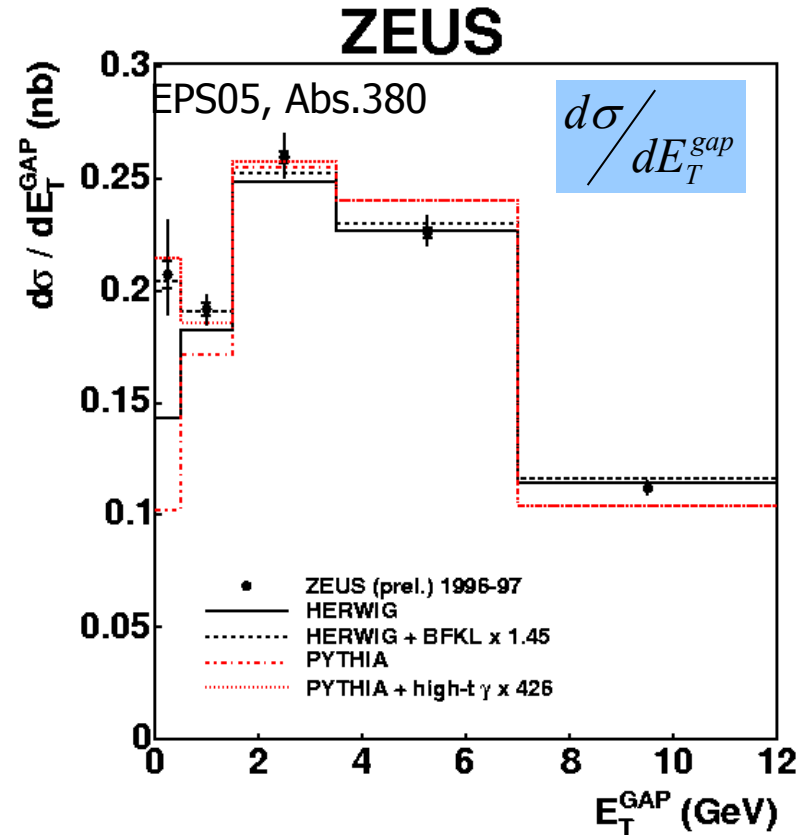

- 3-4% CS exchange necessary to account for small E_T^{gap} cross-section. Amount depends on rapidity separation of jets.

FROM PHOTOPRODUCTION TO DIS



The regime of low Q^2 (and low x)

- For $E_T^2 \geq Q^2$ parton can probe resolved hadronic structure of photon; Resolved photon contributes to hadronic final state.

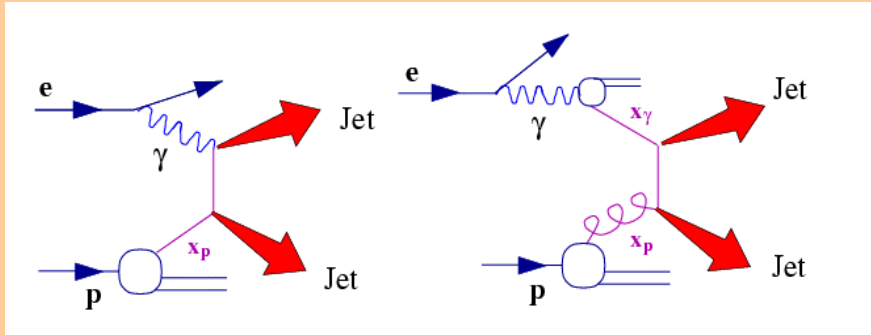

- Structure suppressed with increasing Q^2 .
- x_γ quantifies the amount of the photon's energy that enters the hard scattering: resolved: $x_\gamma < 1$, direct $x_\gamma = 1$.
- Test influence of resolved photon contribution to the DIS dijet cross-section as function Q^2 using the ratio of resolved-over direct-enriched events ($x_\gamma < > 0.75$).

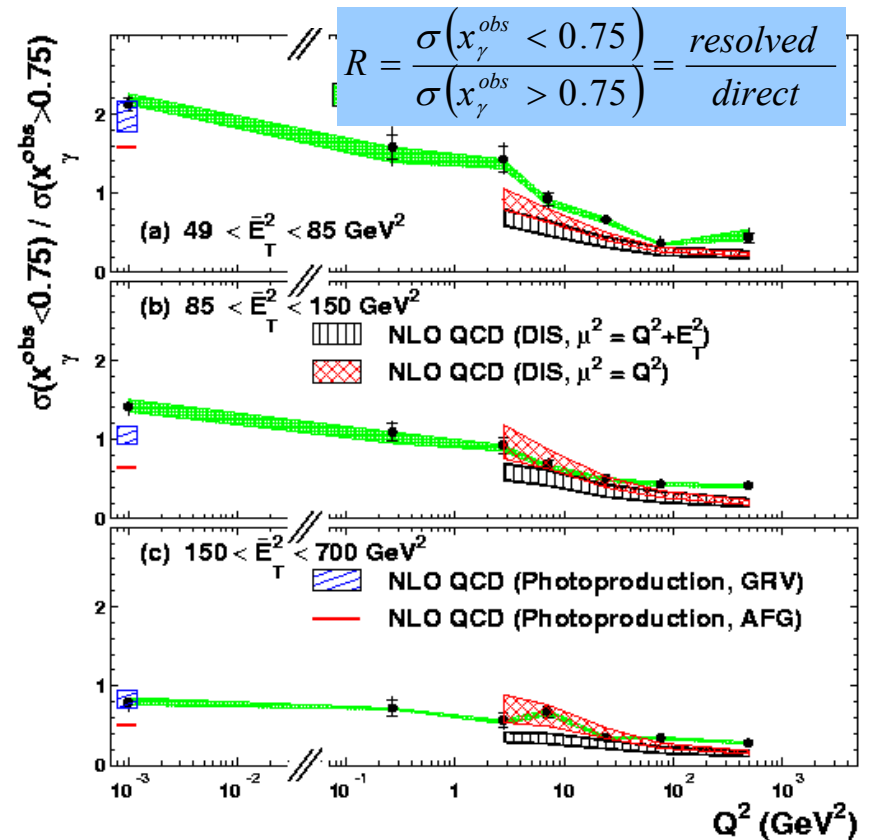

- Resolved relevant for $Q^2 > 100 \text{ GeV}^2$!
- Direct NLO for low $E_T \sim 8 \text{ GeV}$ even at $Q^2 = 5 \text{ GeV}^2$ not enough!
- NNLO? Resummed?

FROM PHOTOPRODUCTION TO DIS



The regime of low Q^2 (2-80 GeV^2) – H1 triple-diff. cross-sections

- H1 data
- HERWIG dir
- HERWIG dir+res_T
- HERWIG dir+res_T+res_L
- CASCADE

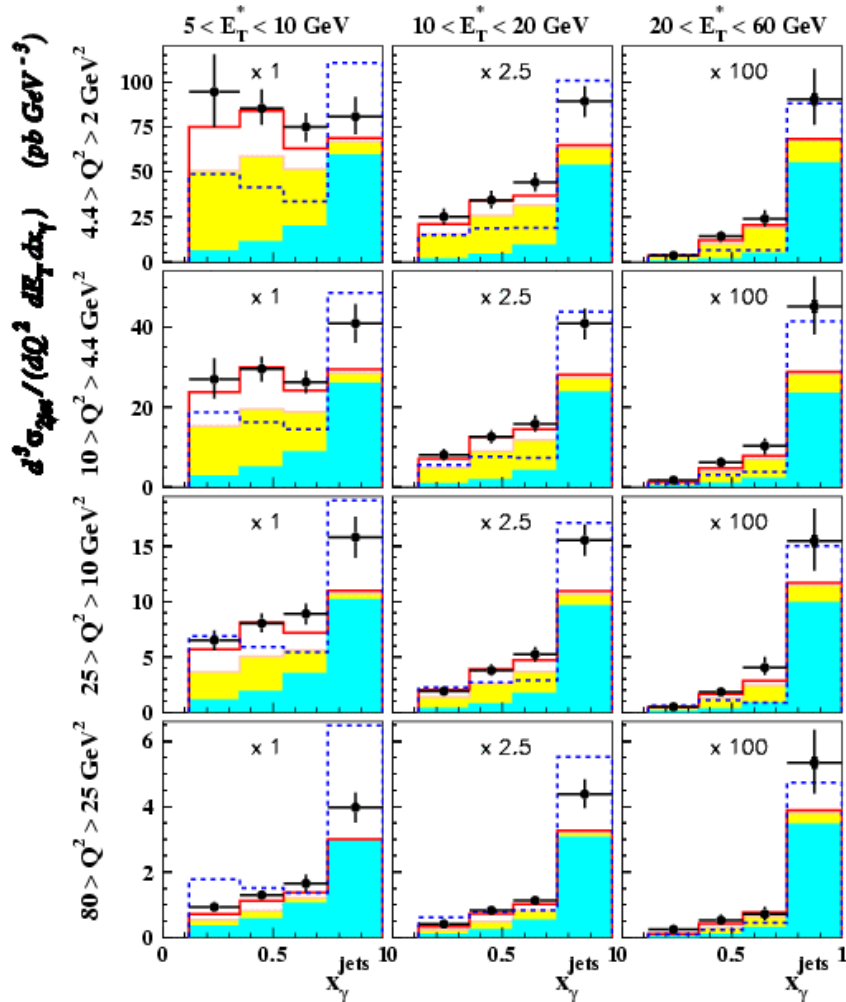

- not shown: direct NLO fails at low Q^2 , resolved decreases with Q^2 increasing. Also JetViP with resolved cannot cover!
- Full LO MC (HERWIG) with resolved contribution reproduces all features of the data (problems at high x_γ).
- Parton shower necessary to describe data at low Q^2 and x_γ !

- Some interplay between resolved (mimicking k_T -unordered!) and CCFM evolution – also CASCADE does a reasonable job (sensitivity to PDF!!!!)

Older study of dijets with small azimuthal separation: 2(3)jet NLO cannot account for the data completely; k_T -non-ordered models (CCFM) do a better job.

FROM PHOTOPRODUCTION TO DIS



The regime of low Q^2 (and low x)

Say something about the S measurement from H1.

FROM PHOTOPRODUCTION TO DIS



Low E_T jets and the photon's PDFs

- Low E_T jets (6 GeV) are sensitive to the gluon content in the photon.
- Large contributions from underlying events
 - subtraction procedure, amount of subtracted energy depends on model!
 - large uncertainties!

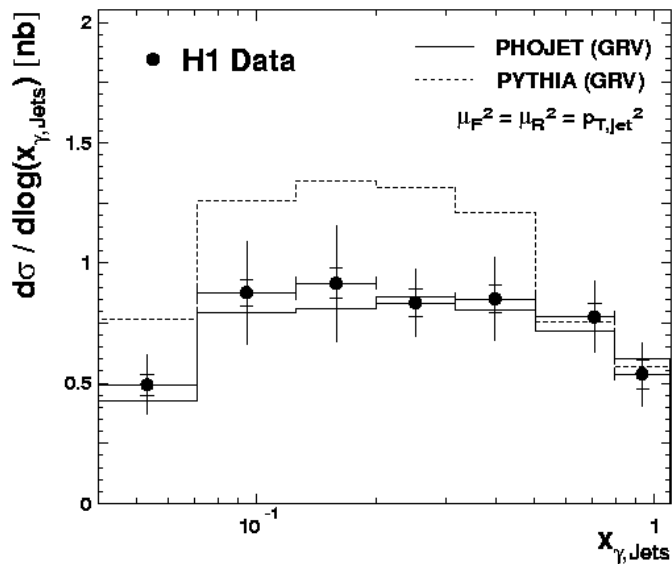
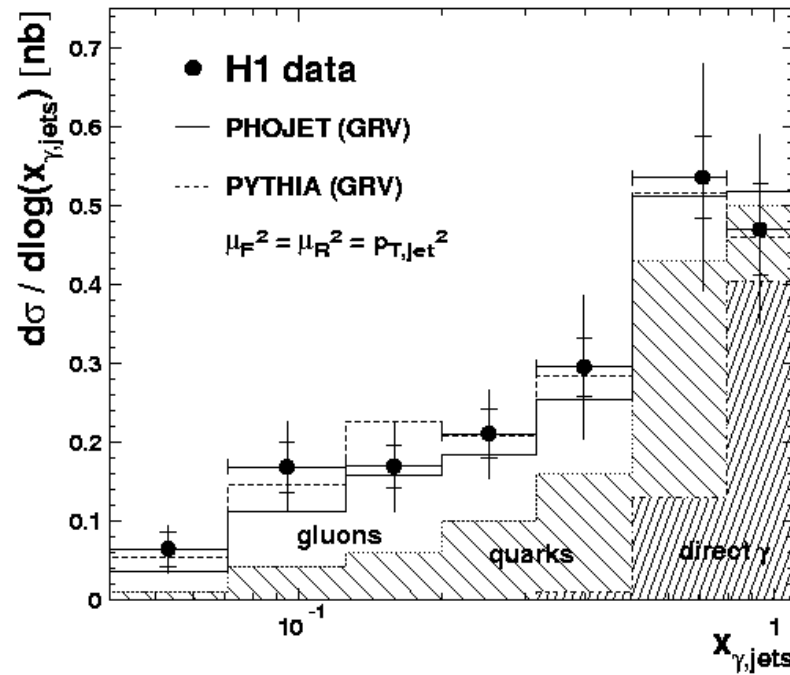

PHOTOPRODUCTION JETS



Low E_T jets and the photon's PDFs

Effective parton distribution

$$f_{\gamma,eff} = (q(x_\gamma) + \bar{q}(x_\gamma)) + \frac{9}{4} g(x_\gamma)$$

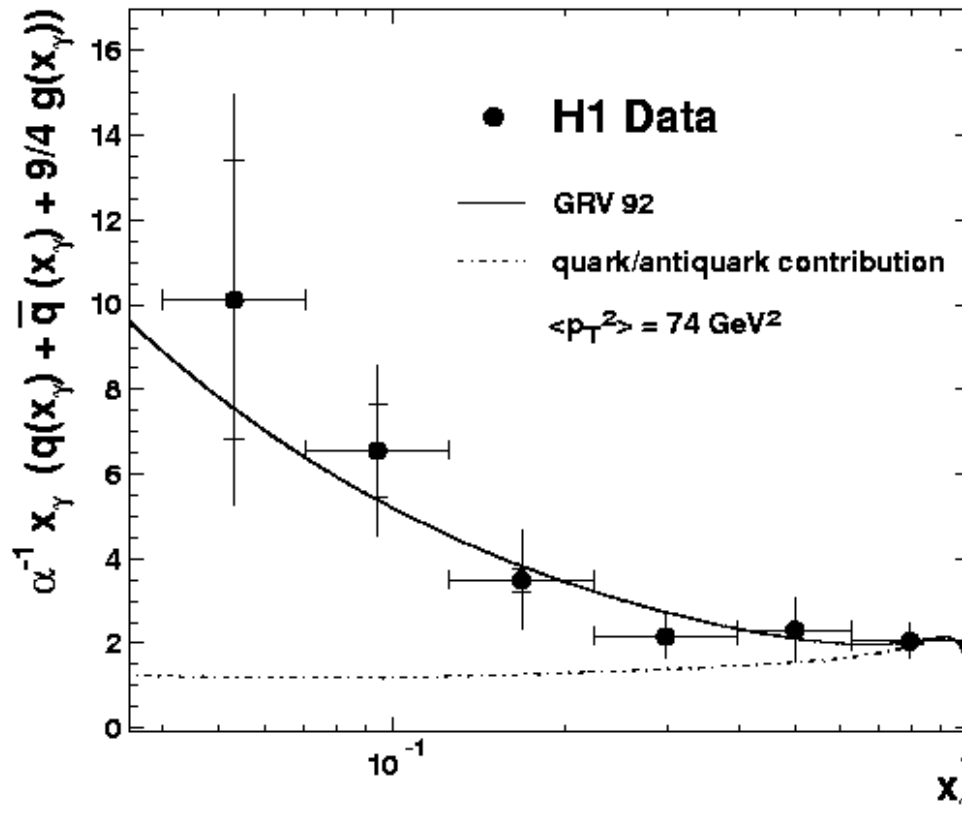

FORWARD JETS



Hunting for signs of BFKL evolution

- Perturbative expansion of evolution equations

$$\sim \sum_{mn} A_{mn} \ln(Q^2)^m \ln(1/x)^n$$

DGLAP: $\sum (\alpha_s \ln Q^2)^n$ calculated to BFKL: $\sum (\alpha_s \ln 1/x)^n$

CCFM: $\ln(Q^2)$ and $\ln(1/x)$

- DGLAP approximation scheme for parton evolution works very well for most of HERA regime (F_2)

-- breakdown
-- can we dis

with x since terms $\ln 1/x$ neglected!

k_T large

**DGLAP:
 k_T ordering!**

**BFKL:
 x ordering!**

x large

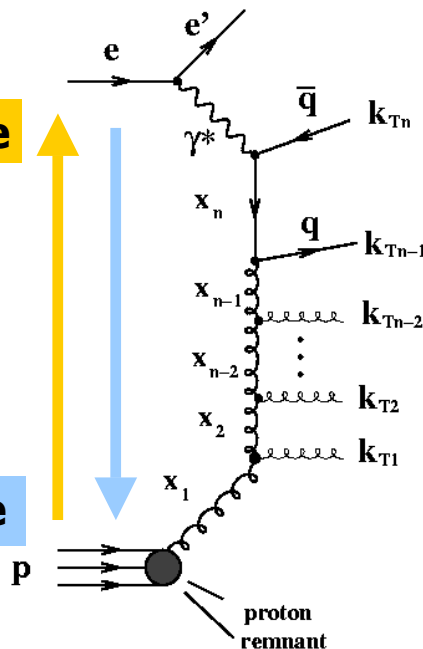

Suppress DGLAP, enhance BFKL:

- forward region: $\eta > 2$ (close to proton)
- jet $E_T^2 \sim Q^2$ (suppressed in DGLAP)
- large $x_{\text{jet}} = E_{\text{jet}}/E_{\text{proton}}$ (realized in BFKL)

All previous results: Problems at low x !
-- NNLO? At all orders all schemes work
-- Resolved? May mimic higher orders
-- Evolution? Is it really BFKL?

H1 AND ZEUS FORWARD JETS



as functions of x – spot problems in evolution?

- only 1997 data, 13.7pb^{-1}
- $5 < Q^2 < 85 \text{ GeV}^2$, $\mu_R = E_T$

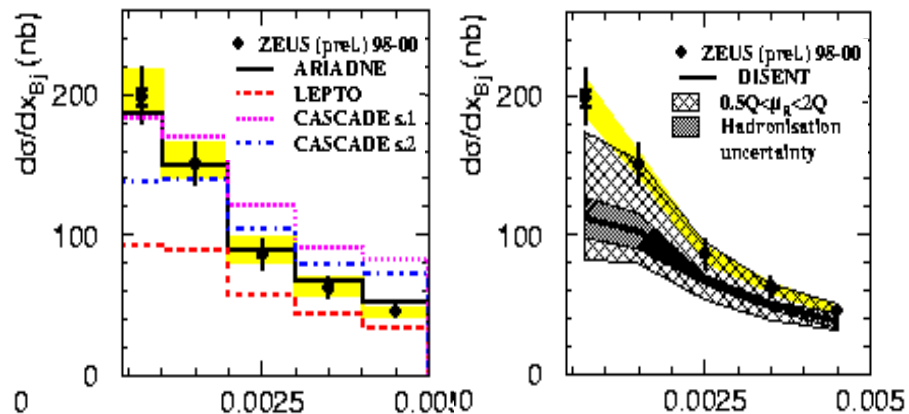
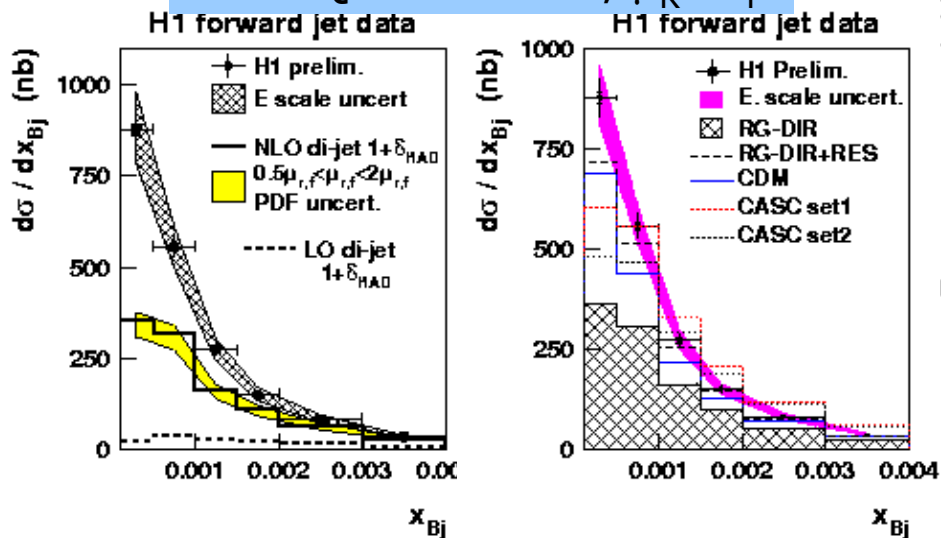

Tighter cuts than H1 → same statistics from 72pb^{-1} of data. $\mu_R = Q$.

- All models below the data at low x values.
- CCFM unclear (PDF dependence!)
- resolved photons / ARIADNE (BFKL-like) better / good
 - is it non- k_T -ordered contribution? But why then CCFM not better?
 - is it mimicking higher orders (NNLO)?
 - is it a photon or a proton feature?

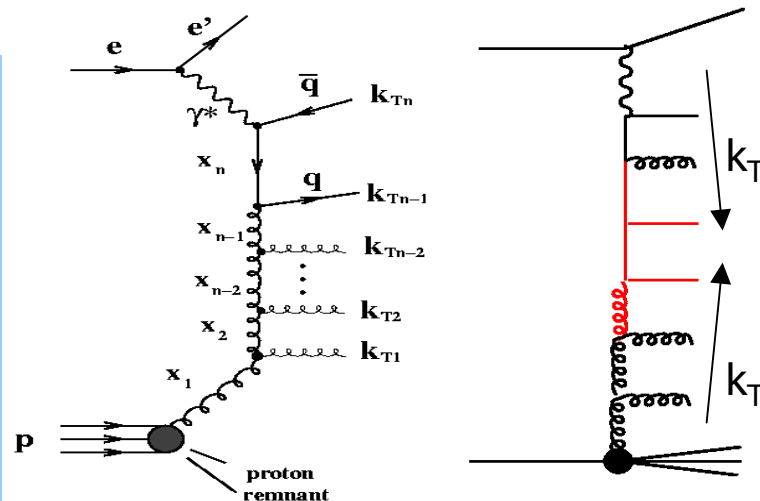

FORWARD JET+CENTRAL DIJETS



Further constraining the phase-space (H1)

H1 then requests dijets in central detector (demand same $E_T > 6$ GeV for all jets \rightarrow no k_T -ordering \rightarrow DGLAP suppressed):

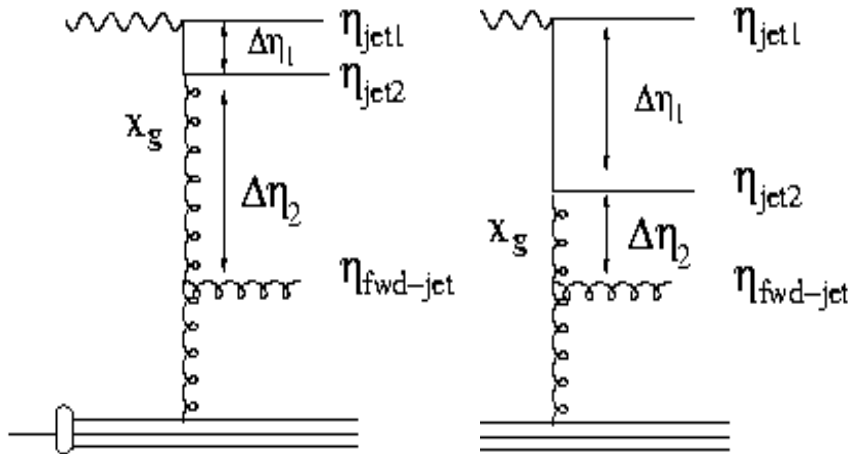

Choice of $\Delta\eta_1, \Delta\eta_2$ selects specific evolution scenarios:

- $\Delta\eta_2$ small \rightarrow no PS for BFKL radiation
- 'BFKL' region: $\Delta\eta_1 < 1, \Delta\eta_2 > 1$
- $\Delta\eta_1 > 1$: resolved photon picture
- But: correct ordering of jets?

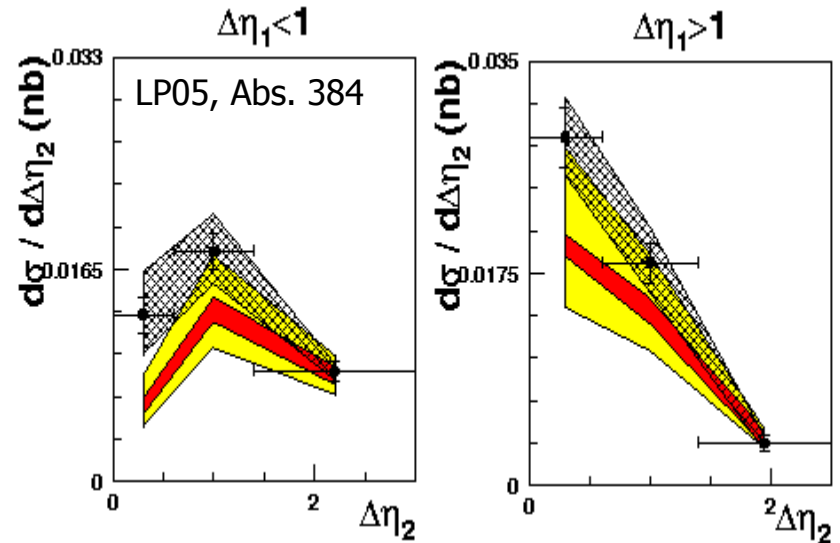

- resolved LO MC describes $\Delta\eta_1 > 1$
- CDM (BFKL-like) better for $\Delta\eta_1 < 1$ than for $\Delta\eta_1 > 1$
- CCFM PDF set 2 describes 'BFKL' region

CONCLUSION: UNCLEAR!