

Heavy quark production at HERA and its relevance to the LHC

Matthew Wing (UCL)

- Introduction
- Measurements and description of heavy quark production
- Heavy quark contribution to the proton structure
- Universality of fragmentation
- Summary

Introduction and motivation

Why study heavy quarks?

To understand and probe QCD in as much detail as possible

Parton densities of proton and photon need to be precise. *cf* future colliders, pp , e^+e^- and $\gamma\gamma$, ...

QCD-production rate should be accurately understood which can be a significant background to “new” physics

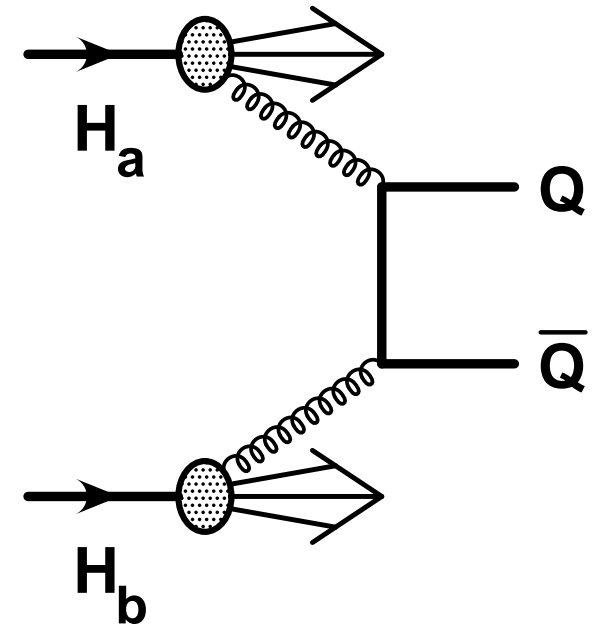

Why study heavy quark production?

Example of why the heavy quark production rate needs to be understood (ATLAS TDR)

Consider $b\bar{b}H/A$ with $H/A \rightarrow b\bar{b}$ production at the LHC

Even requiring four b jets, $S/B \sim \text{few } \%$

Background from gluon splitting to $b\bar{b}$ and $gg \rightarrow b\bar{b}$

5σ discovery possible if QCD backgrounds known precisely

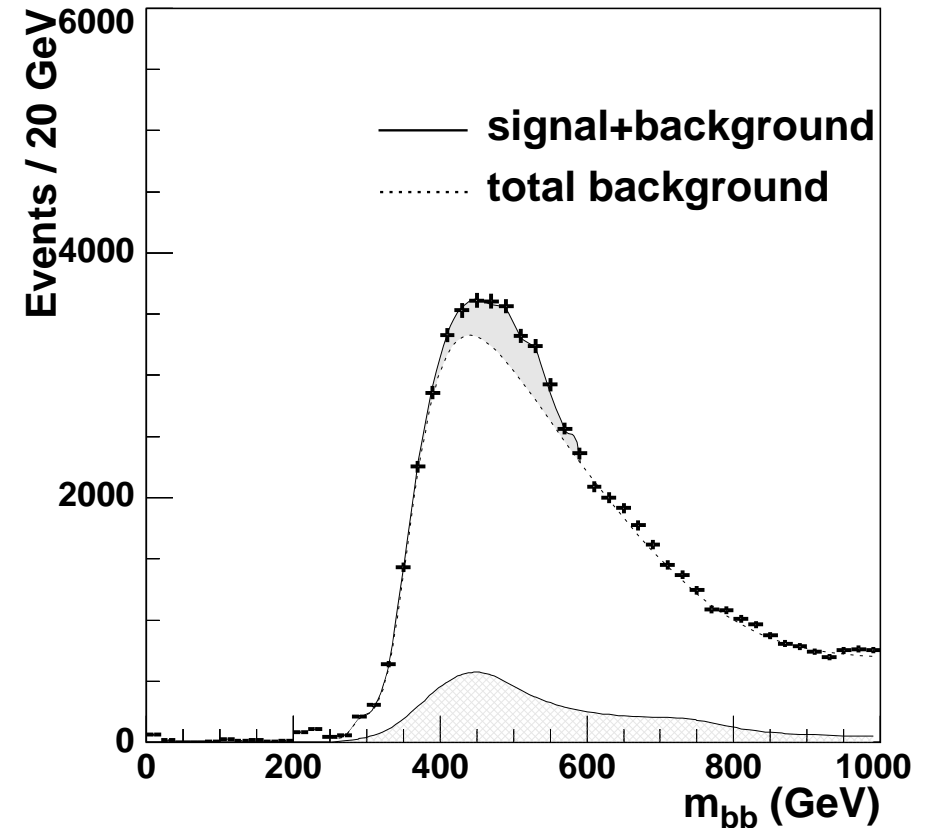

$$m_A = 500 \text{ GeV}$$

How well is the QCD background known?

Generic nature of production

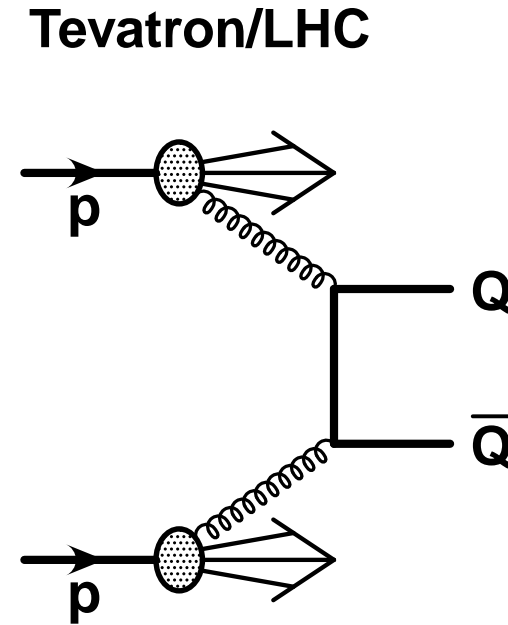
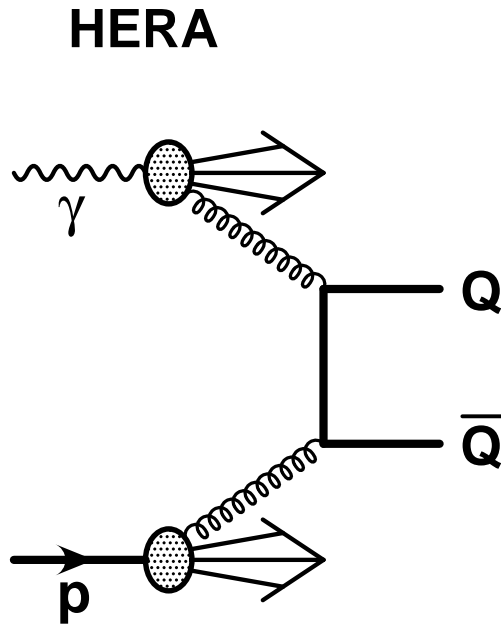

PDF →

Structure functions of
proton and photon

Direct sensitivity to the
gluon content

Hard scatter →

Dynamics of NLO QCD

Implementation of
diagrams and dynamics
into programs

Fragmentation

Description of parton-
hadron transition

Non-perturbative, but
essential.

Theoretical calculations

Discriminating different schemes

Fixed order:

- Frixione et al. (FMNR) used for charm and beauty in photoproduction.
- Harris and Smith (HVQDIS) used for charm and beauty in deep inelastic scattering.

Next-to-leading log:

- Cacciari et al. and Kniehl et al. used for charm and beauty in photoproduction. NB. only inclusive production, cannot do e.g. dijets
- No program for deep inelastic scattering.

Combined, FONLL (Cacciari et al.), used for charm in photoproduction.

New program, MC@NLO (Frixione and Webber), which is the fixed-order program with parton showers and hadronisation from HERWIG - not available for HERA.

Fragmentation of heavy quarks

Reliant on non-perturbative models, e.g. Lund, cluster to describe fragmentation

NLO QCD calculations usually add on a Peterson function

Are the models and current parametrisations correct?

- Measure the fragmentation function
- Make measurements where the effects are reduced; jets, high energy

What can HERA provide and the LHC want to know?

General state of description (by MC, NLO) of heavy quark production processes:

- where the heavy quark is produced in the hard scatter
- no direct information on gluon splitting

Information on the proton PDFs:

- gluon content information is good
- heavy quark content is for the future

Details of the fragmentation in a hadronic environment; fragmentation functions, fractions, etc..

No information yet on multiparton interactions in heavy quark processes.

Can provide information on topology of events and jets useful for designing algorithms/triggers.

Open heavy quark production

Beauty production at the Tevatron Run I

Significant disagreement with QCD

Extrapolation to the the b quark level \rightarrow

Measurement of B mesons gives more reliable results

Led to improvement in theory

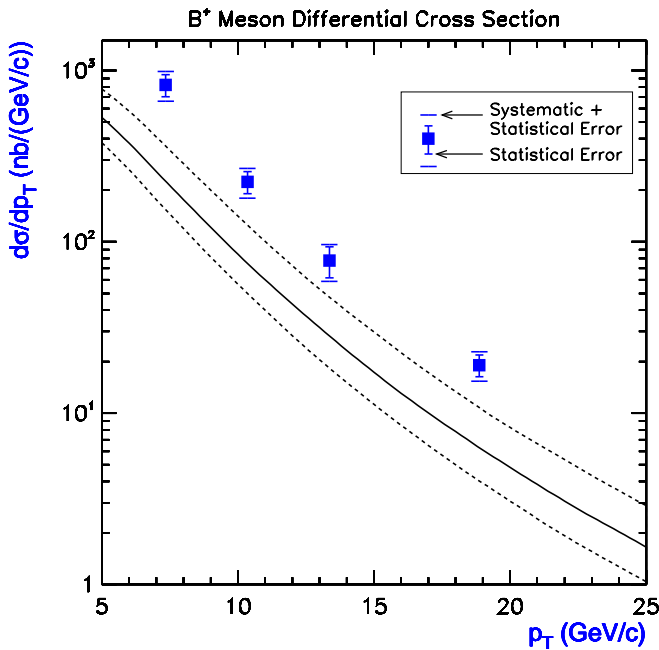
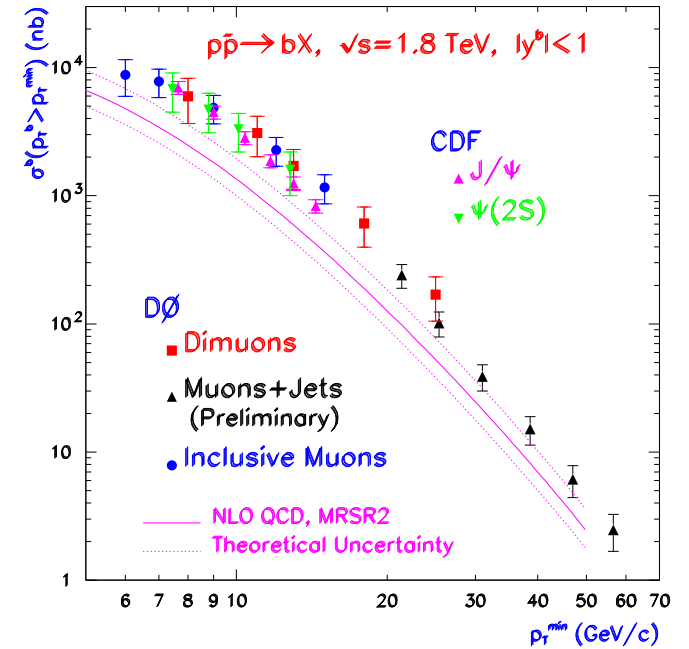
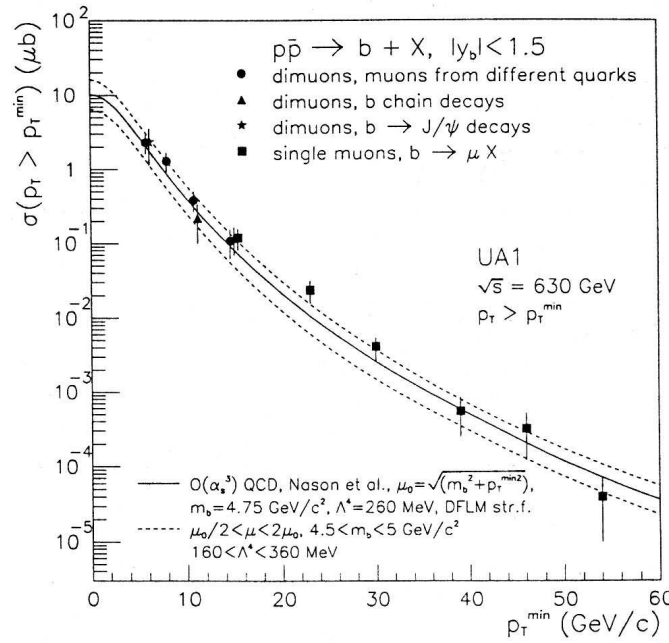

Fragmentation
 \rightarrow in theory \rightarrow
 tuned to data

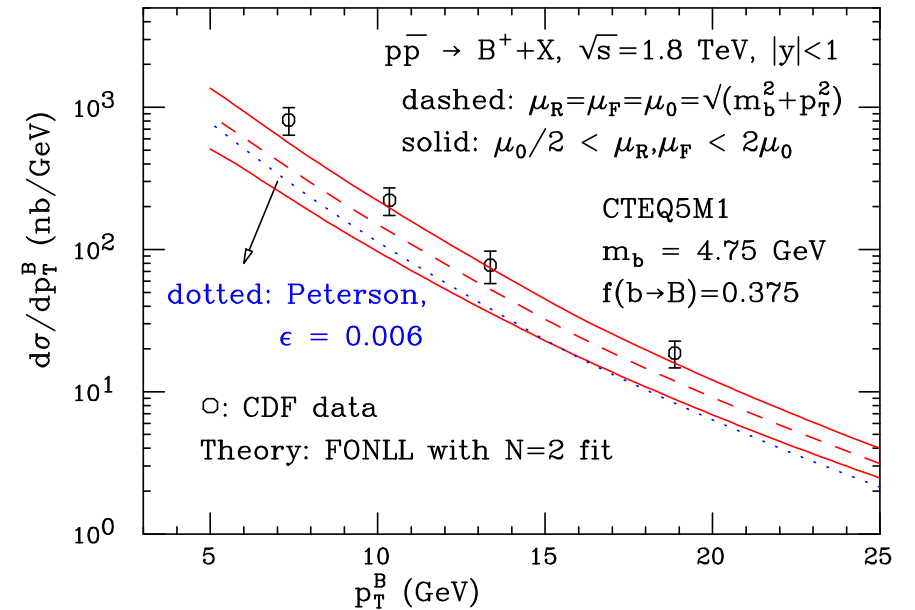

Latest TeVatron beauty measurement

Run II data compared with latest theory.

Data go to very low p_T . Valuable to have inclusive measurements.

Improved theory, FONLL (and MC@NLO), describe the data well.

Clearly defined measured cross section

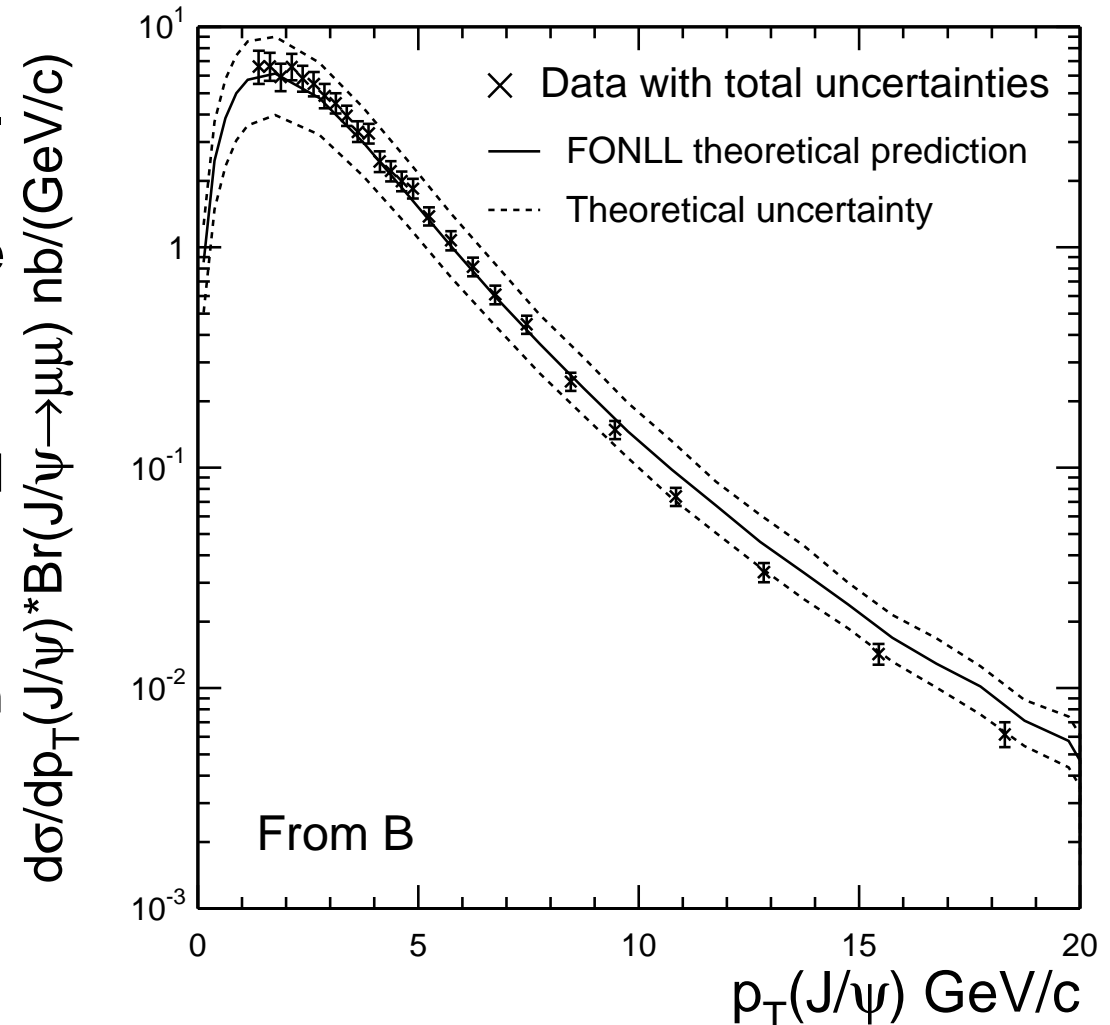

Predictions of FONLL and MC@NLO at HERA would be useful.

Global comparison with hadron colliders

O.Gutsche, J. Butterworth, A. Geiser, B. Waugh

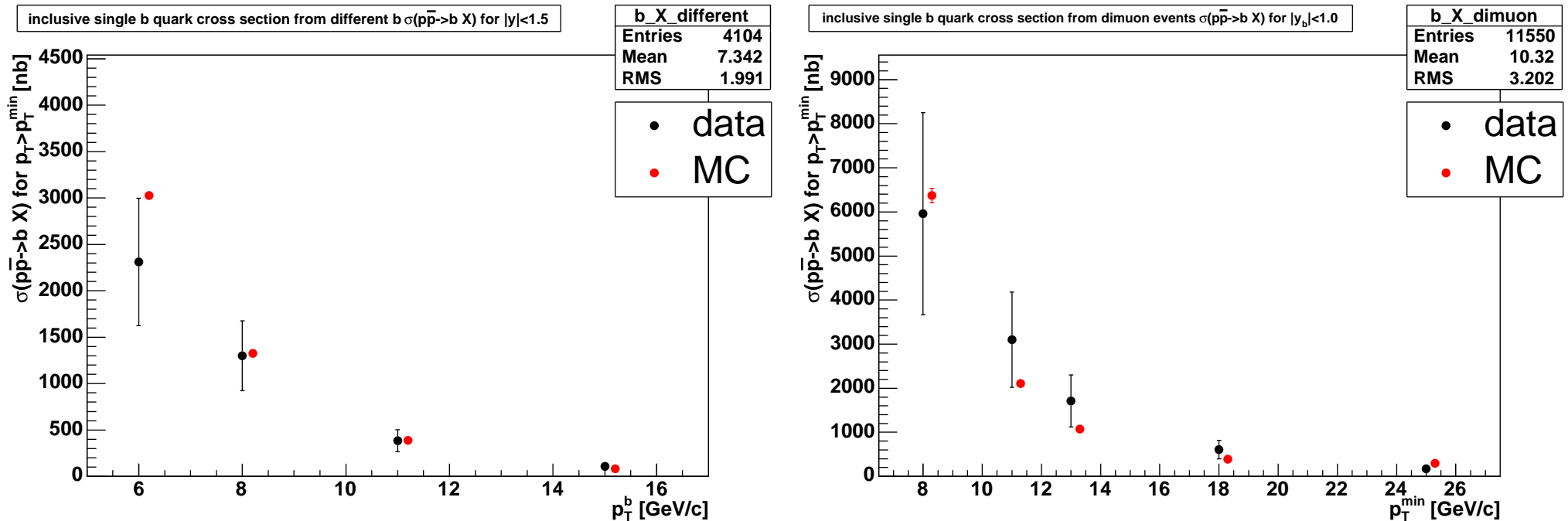

Good description of UA1 (630 GeV) and D0 (1800 GeV) data using same model.

Good MC model to use for LHC predictions: normalisation is good, complete final state.

Need to compare to all hadron-hadron data; being built up.

Comparison with HERA

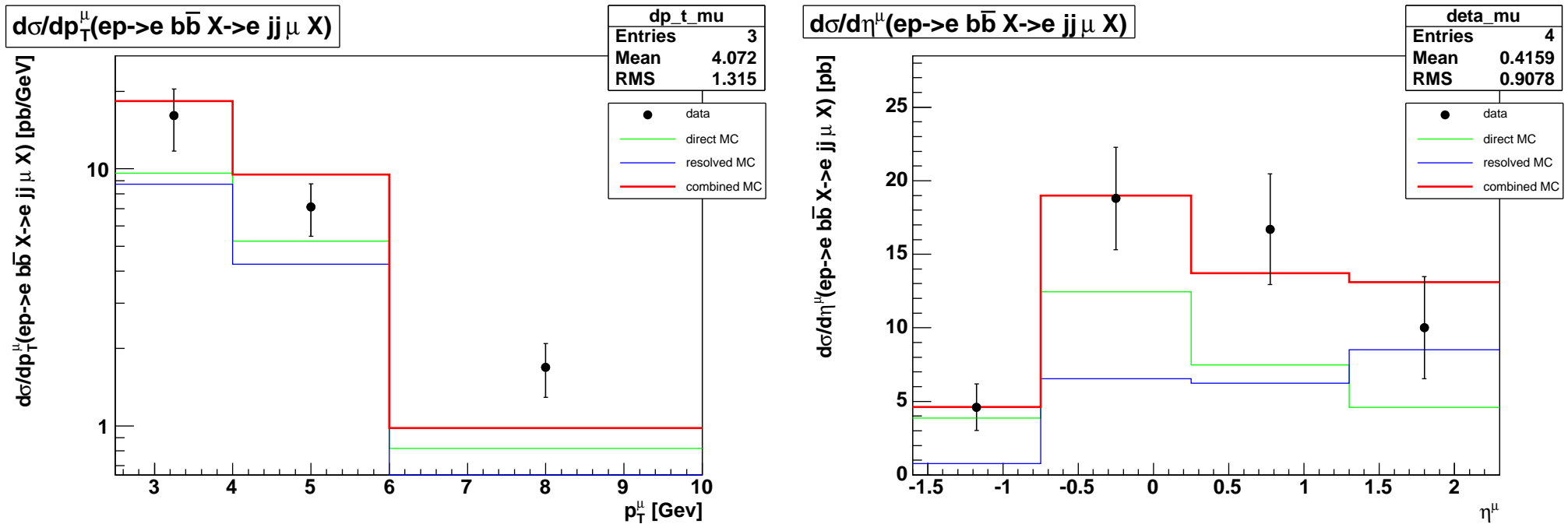

Good description of HERA data.

Shows the value of general-purpose calculations.

Have shown examples of where the procedure works. Not perfect description of all variables (yet).

But the best model so far?

Beauty discussion

Situation developed rapidly and conclusions changed, but converging

Many different kinematic regions measured and assumptions made; treat extrapolations with caution

Data are described by NLO QCD, but issues remain

Should treat any extrapolation with caution; large extrapolation factors, into unmeasured regions, uncertainties considered...

More data is needed and is coming...

More calculations needed and improved phenomenological understanding

Global fits to all data would be useful for checking consistency

Need programs which can describe all reactions e.g MC@NLO should be able to calculate all cross sections

Charm in deep inelastic scattering

NLO (HVQDIS) prediction gives reasonable description of the data

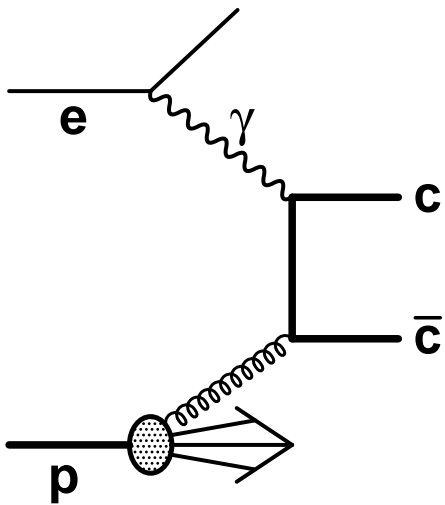

Sensitive to the gluon density in proton → more later

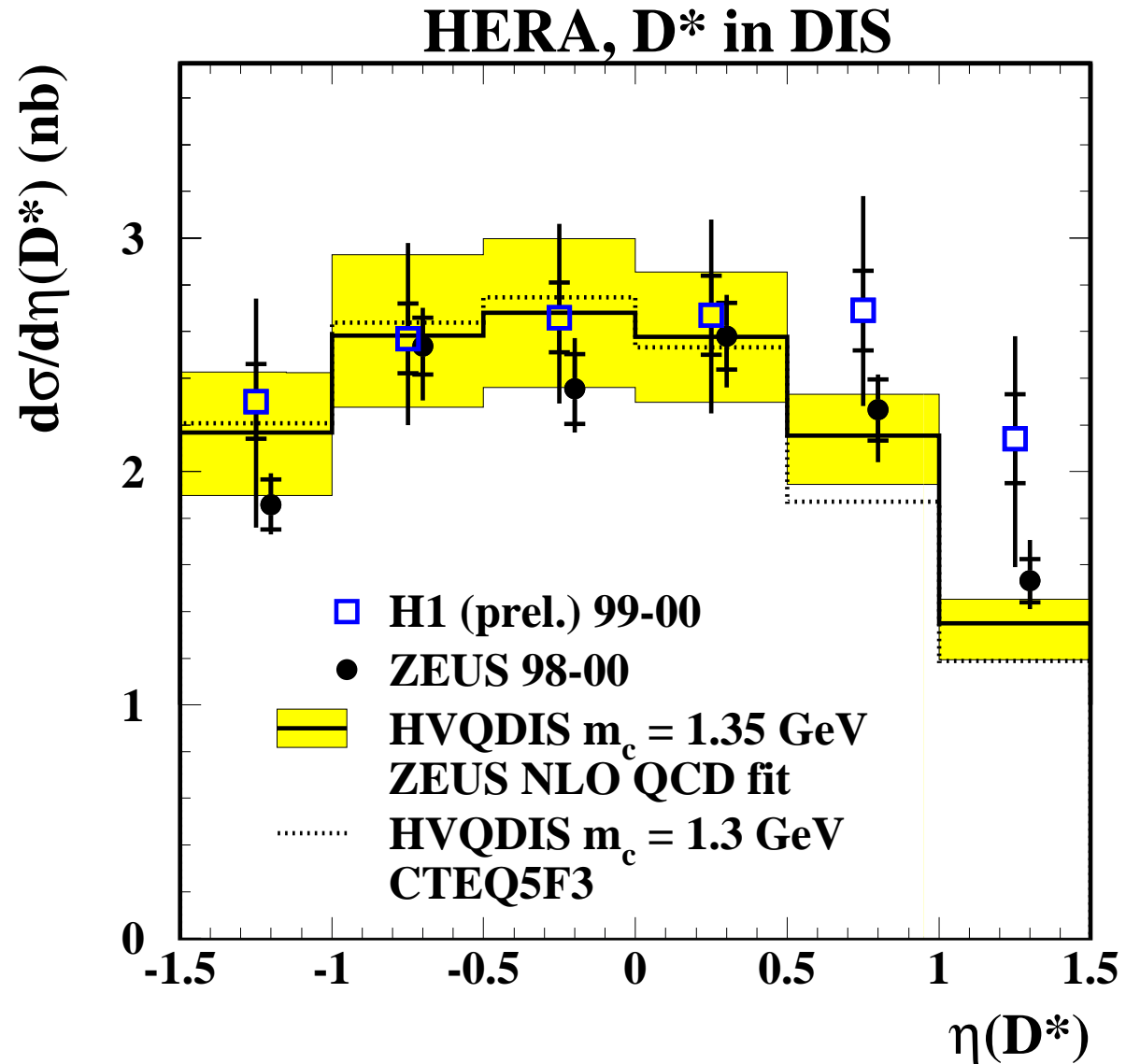

Charm in photoproduction

ZEUS

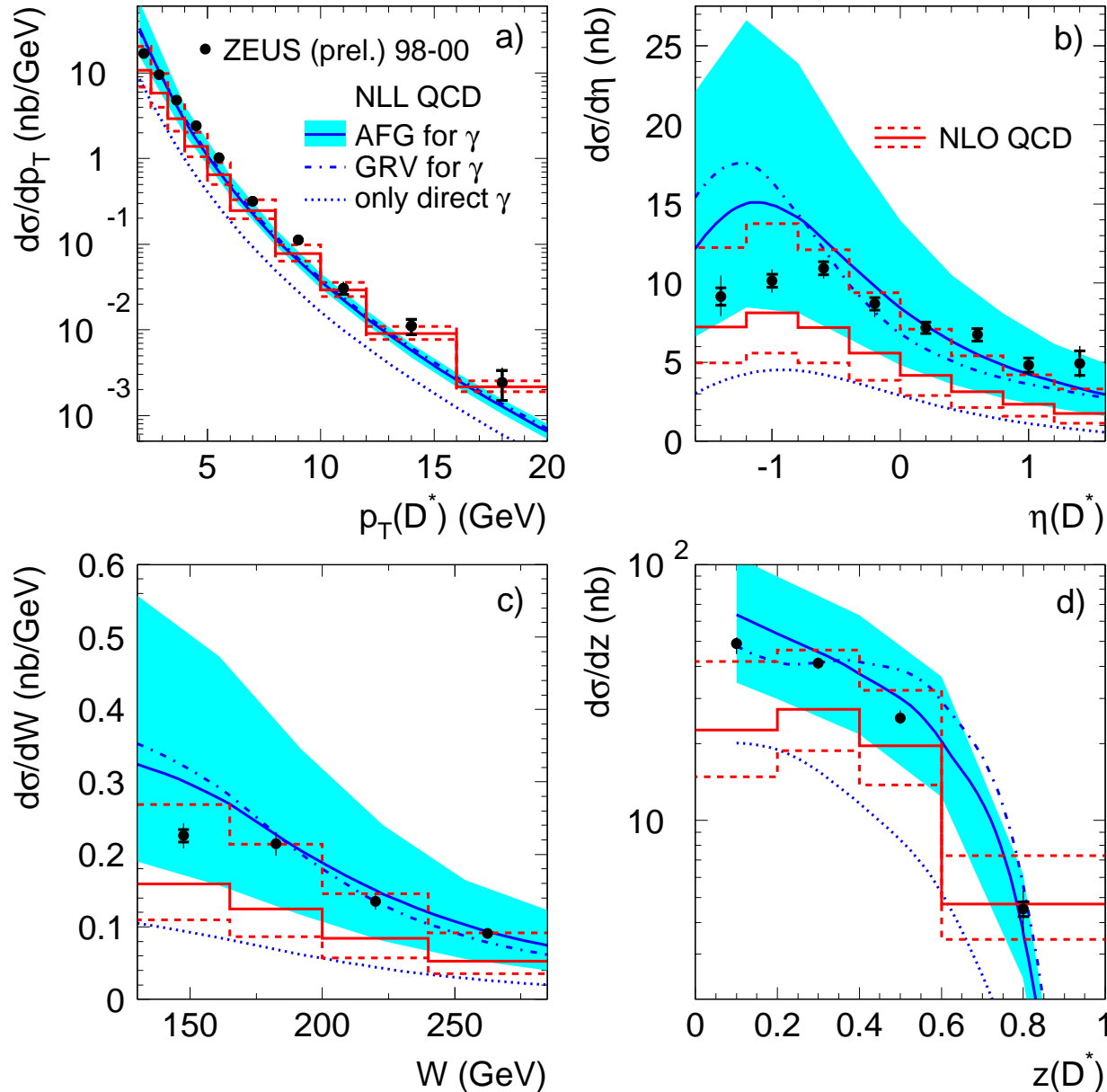

Description by NLO/NLL QCD not perfect.

General description with caveats
- double differential cross sections highlight differences

Is QCD really predictive?

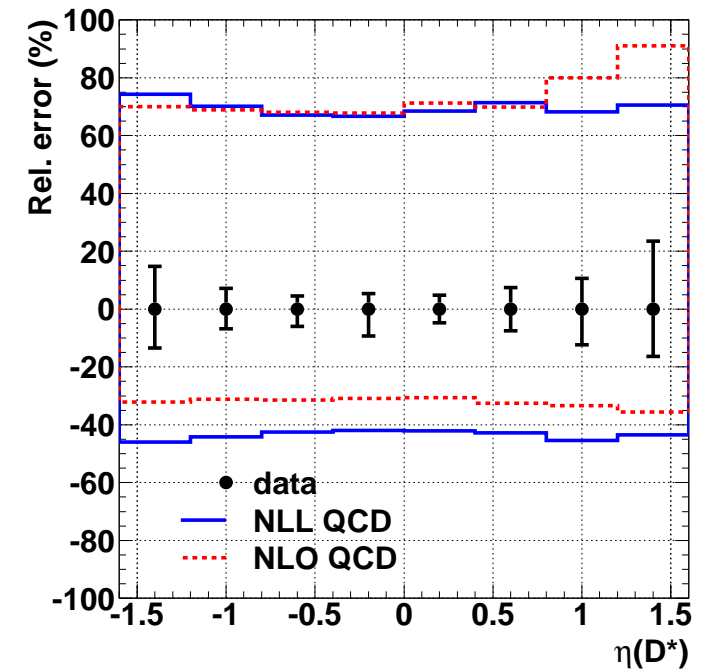

Data also good for tuning theory

Charm in dijet photoproduction

Isolated areas where NLO calculation does not describe data

- low x_γ^{obs}
- regions where higher-order contributions are large

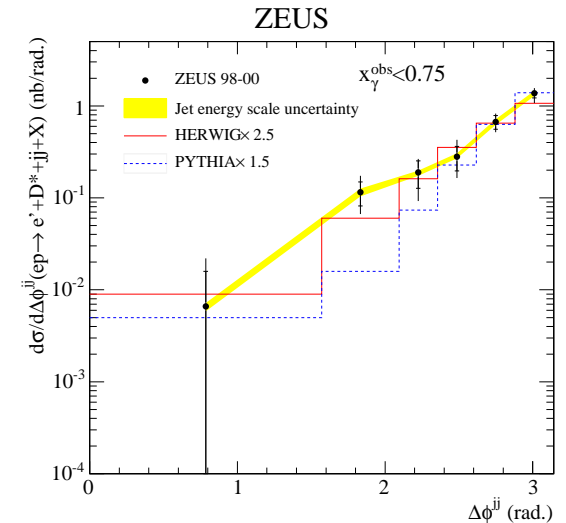
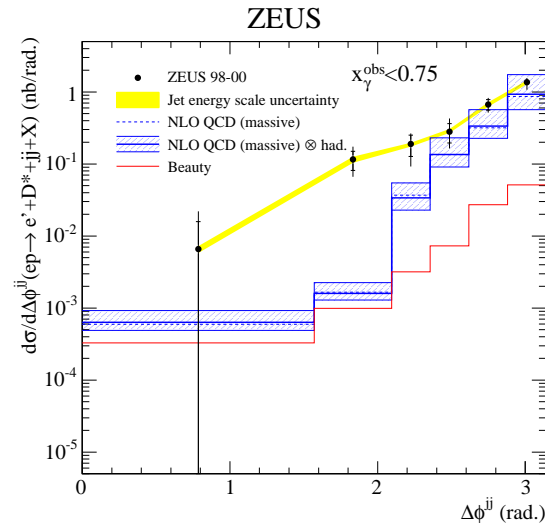

Summary

Overall description of charm photoproduction within $\sim 50\%$ and within (large) theoretical uncertainties.

But assuming your NLO calculation is right everywhere: e.g. designing a trigger; calculating QCD backgrounds, could get you into trouble.

Heavy quark contribution to the proton structure

Proton structure

$$\frac{d^2\sigma^{Q\bar{Q}}(x, Q^2)}{dx dQ^2} = \frac{2\pi\alpha^2}{xQ^4} \left\{ [1 + (1 - y)^2] F_2^{Q\bar{Q}}(x, Q^2) - y^2 F_L^{Q\bar{Q}}(x, Q^2) \right\}$$

Potentially large extrapolations for tagged D mesons:

$$F_{2,\text{meas}}^{Q\bar{Q}}(x_i, Q_i^2) = \frac{\sigma_{i,\text{meas}}(ep \rightarrow D^* X)}{\sigma_{i,\text{theo}}(ep \rightarrow D^* X)} F_{2,\text{theo}}^{Q\bar{Q}}(x_i, Q_i^2)$$

Extraction of $F_2^{Q\bar{Q}}(x, Q^2)$ is dependent on the scheme.

Inclusive measurements less reliant on models and go to $p_T \sim 0$

Charm contribution to the proton structure function

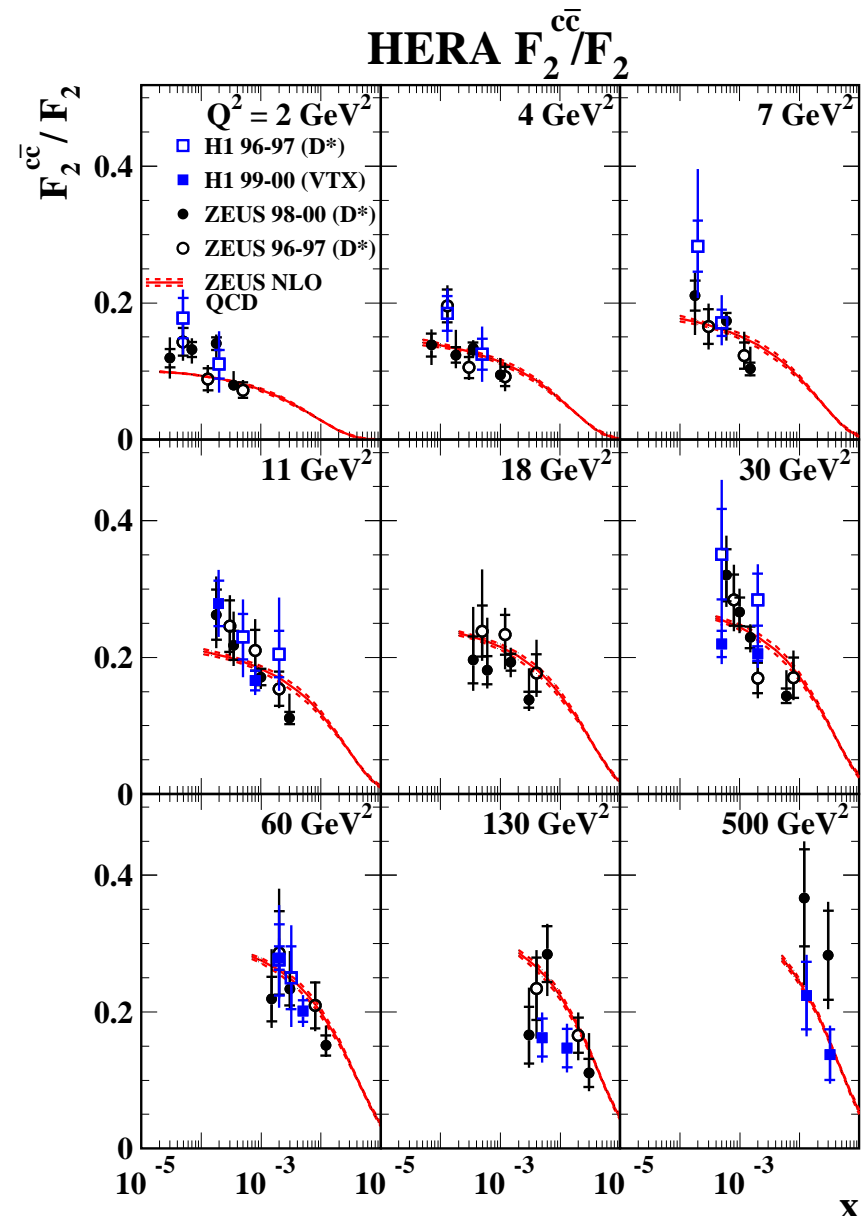
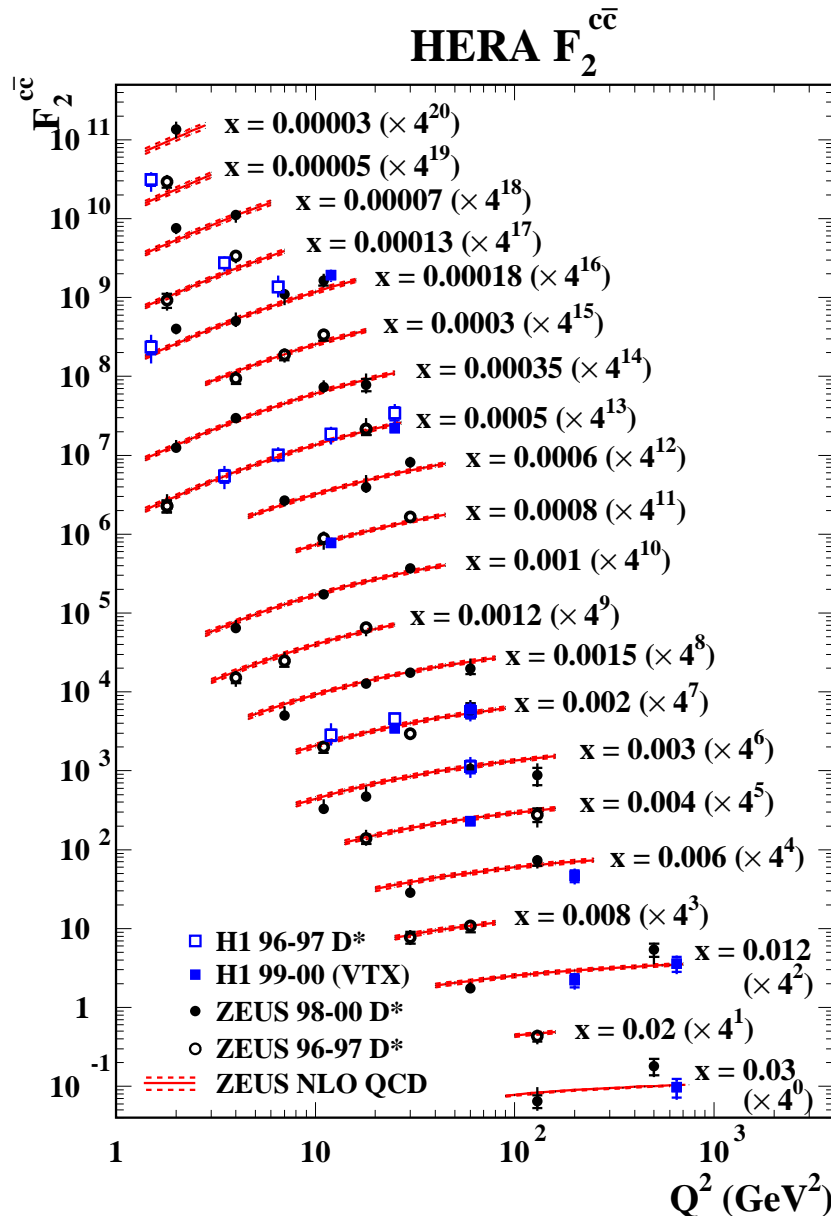

Charm production represents a significant amount of the inclusive cross section

Beauty contribution to the proton structure function

Inclusive measurements well described by QCD

Much smaller fraction of total cross section compared to charm

Sensitivity to choice of PDF

Higher statistics and higher Q^2 will be useful for LHC

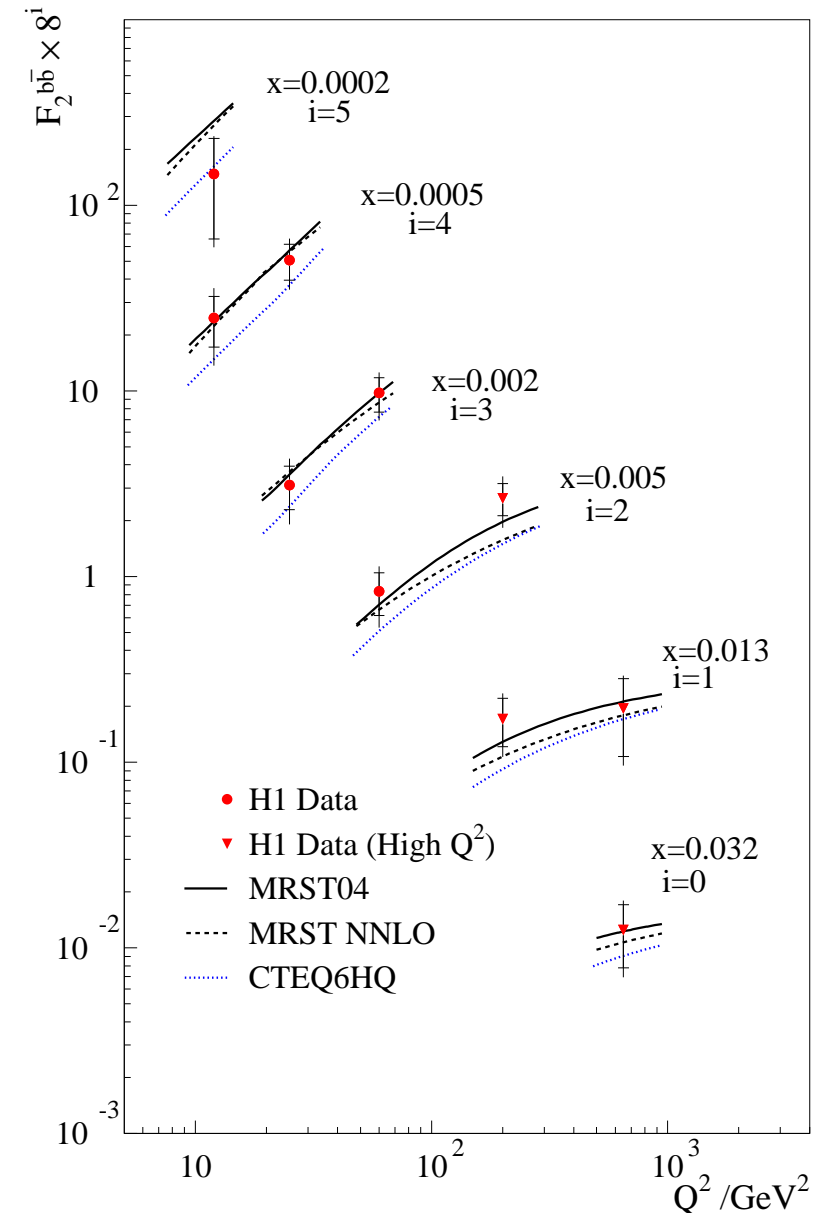

Universality of fragmentation

Charm fragmentation parameters

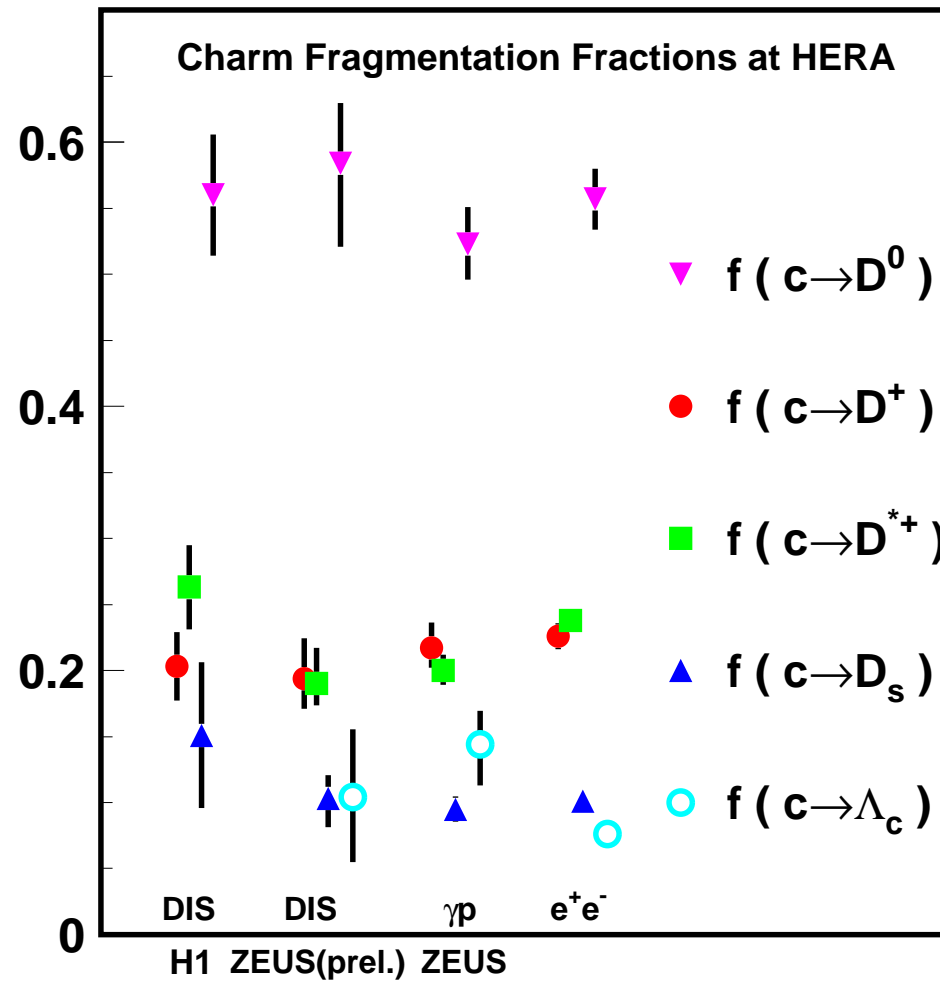

Charm fragmentation fractions are universal

Same measurements at the TeVatron could be made

Correct values being used in NLO calculations

Charm fragmentation function

Measurements at hadronic colliders are important:

- Independent ways of measuring fragmentation
- Extra constraints and precision on fragmentation function
- Consistency in more complicated environment - hadron remnant?

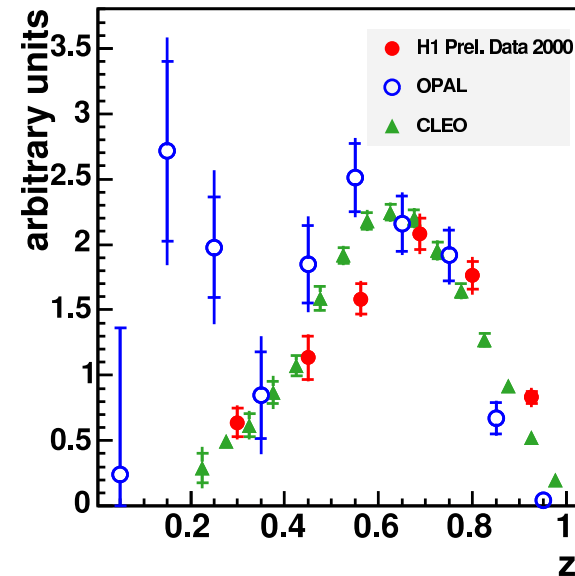

H1 hemisphere method

$$\langle \sqrt{s} \rangle \approx 10 \text{ GeV},$$
$$z = \frac{(E+PL)_{D^*}}{\sum_{\text{hem}}(E+p)}$$

OPAL $\sqrt{s} = 91.2 \text{ GeV}$,

$$z = 2E_{D^*}/\sqrt{s}$$

CLEO $\sqrt{s} \approx 10 \text{ GeV}$,

$$z = p_{D^*}/p_{\text{max}}$$

General trend is similar for e^+e^- and ep

Different processes, energies, z definitions \rightarrow need consistent fit to all data in MC and NLO.

Improve measurements at HERA and hopefully have measurements at the TeVatron \rightarrow useful input for the LHC.

Conclusions

Increasing number of high precision measurements of heavy quark production from HERA.

Primary goal: measure $F_2^{Q\bar{Q}}$ as accurately as possible and over as wide a kinematic range as possible.

More quantitative statement on b production rates: data vs. theory

Calculations which are proven against many different processes and cross sections

Demonstration of fragmentation function universality (or not)