

# Production and Properties of Heavy Flavours at HERA



Jerome Whyte - York University

On Behalf of H1 and ZEUS  
Collaborations



Mar. 5 - 11, 2006

Overview:

- HERA Collider
- $c/b$  production
- Charm Fragmentation
- Charm/Beauty Jet Cross Sections
- Charm and Beauty Contributions to the Proton Structure function  $F_2$

20<sup>th</sup> Recontres de la Vallée d'Acoste  
La Thuile Mar. 5 - 11, 2006

## Introduction

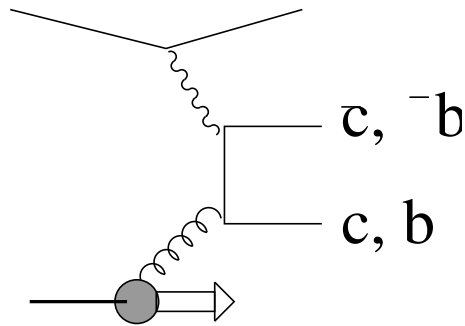

Why study heavy quark production at HERA?

- Heavy quark production can be used as a test of perturbative QCD due to the large mass scale of the quark
- Understanding heavy quark production will be useful for LHC experiments where beauty and charm will be produced at high rates as background

This talk will focus on a few of the most recent results.

## The HERA Collider: H1 and ZEUS

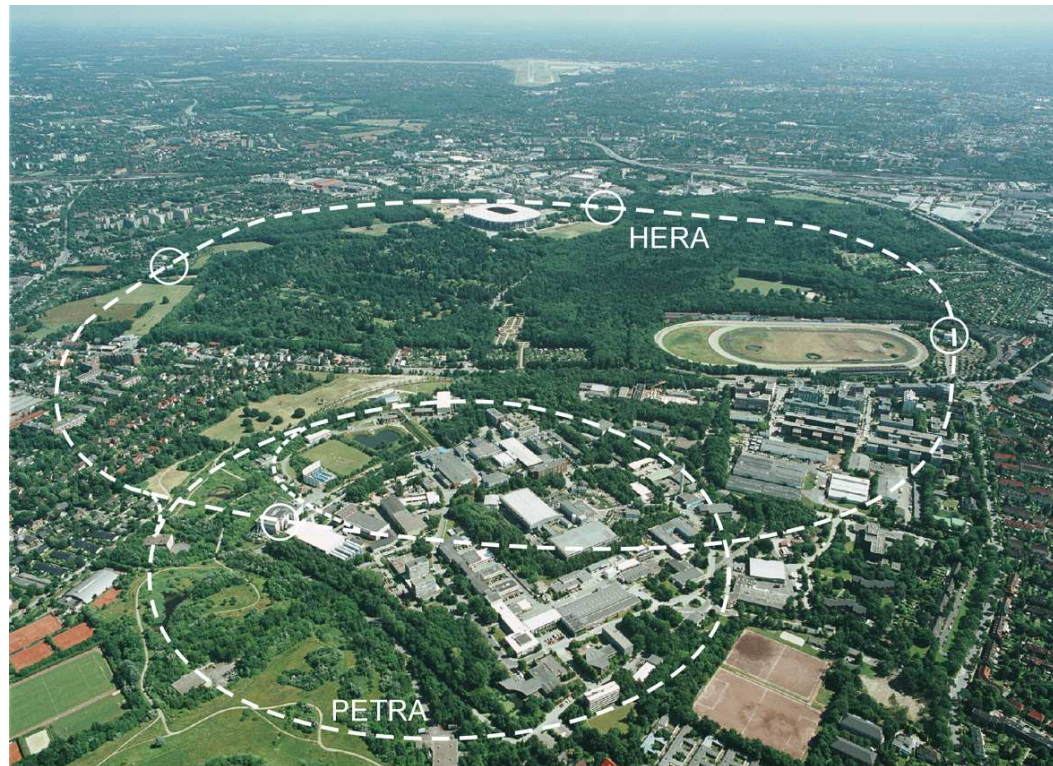

### HERA I

- 820/920 GeV proton beam, 27.5 GeV  $e^\pm$  beam
- Beam spot  $150 \times 30 \mu\text{m}^2$
- Integrated Lum.  $135 \text{ pb}^{-1}$  (94-00)

### HERA II

- 920 GeV proton beam, 27.5 GeV  $e^\pm$  beam
- Beam spot  $80 \times 20 \mu\text{m}^2$
- Int. Lum.  $160 \text{ pb}^{-1}$  (03-05 More to come!)
- $e^\pm$  beam long. polarized ( $\approx 30\%$ )

H1 and ZEUS are two experiments at HERA studying these electron proton interactions

## $c/b$ Productions

At HERA charm/beauty production is dominated by Boson Gluon Fusion (BGF)  $\gamma g \rightarrow Q\bar{Q}$ .

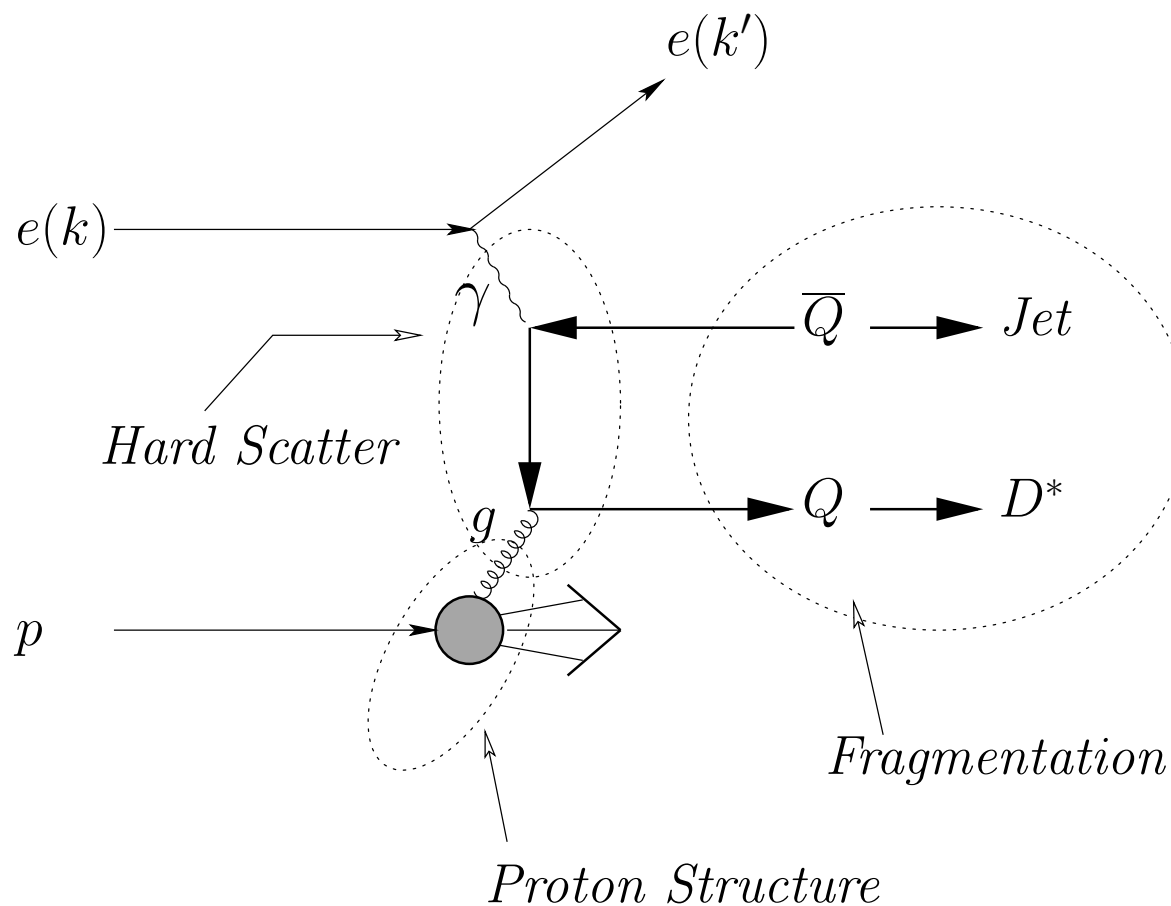

- $\gamma$  from  $e$  and  $g$  from the proton *fuse* producing a  $Q\bar{Q}$  pair
- $x$ : Bjorken scaling variable (fractional momentum carried by struck parton)
- $y$ : fraction of energy transferred from  $e$  to  $p$  (in  $p$  rest frame)
- $Q^2 = -q^2 = -(k - k')^2$
- Two kinematic regimes:
  - Photoproduction ( $\gamma p$ ),  $Q^2 < 1 \text{ GeV}^2$
  - Deep Inelastic scattering (DIS),  $Q^2 > 1 \text{ GeV}^2$

- Factorization

$$\sigma = \text{proton PDF} \otimes \sigma_{\gamma g \rightarrow Q\bar{Q}} \otimes \text{photon PDF} \otimes \text{fragmentation process}$$

## How is Charm Measured?

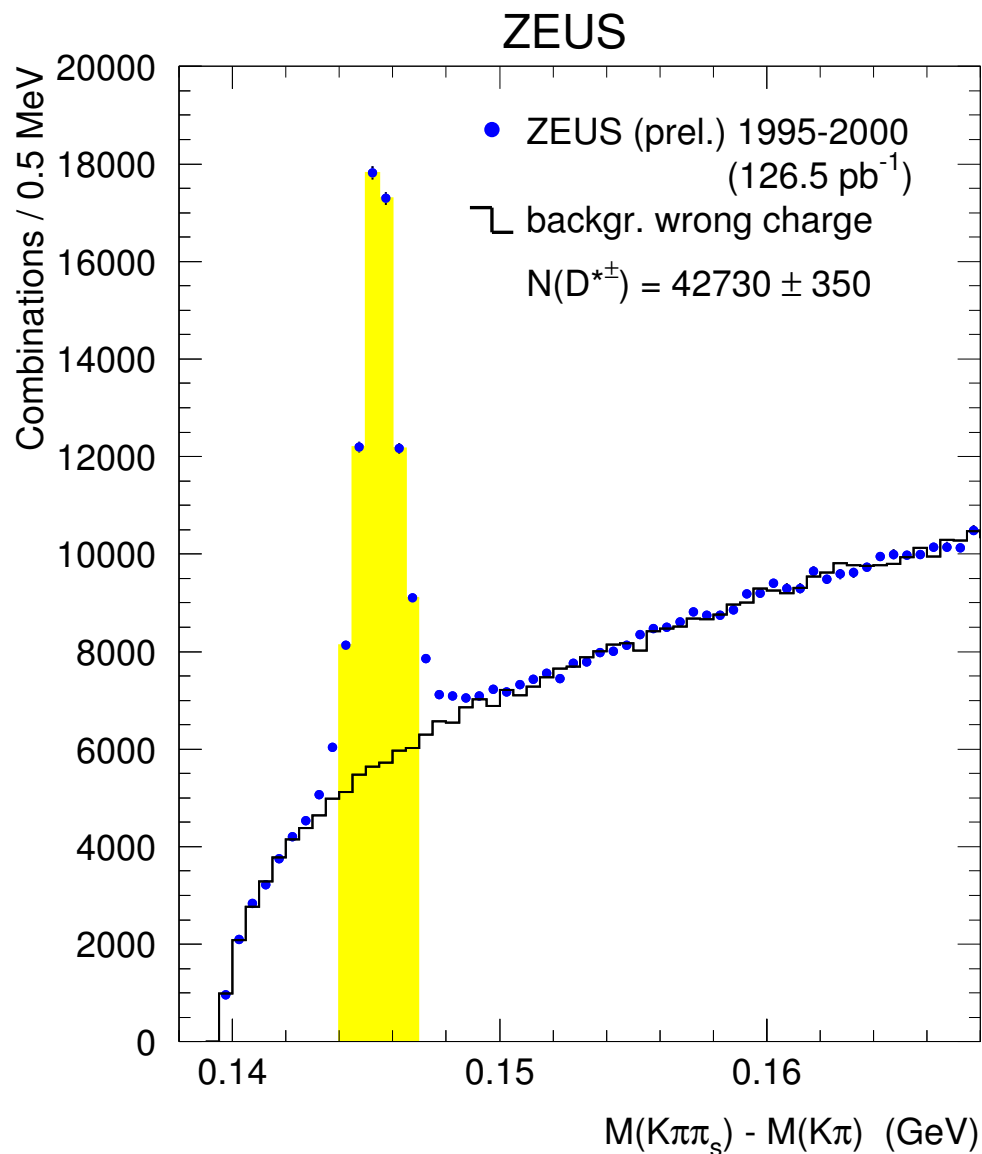

- The charm hadrons used to measure charm cross sections are  $D^0$ ,  $D^+$ ,  $D^*$ ,  $D_S$ ,  $\Lambda_C$
- Left is the  $D^*$  signal measured at ZEUS
- Semileptonic decays ( $c \rightarrow \mu X$ ) are also used
- An inclusive lifetime tag method is also used to measure charm (will be explained later)

## Charm Fragmentation Fractions

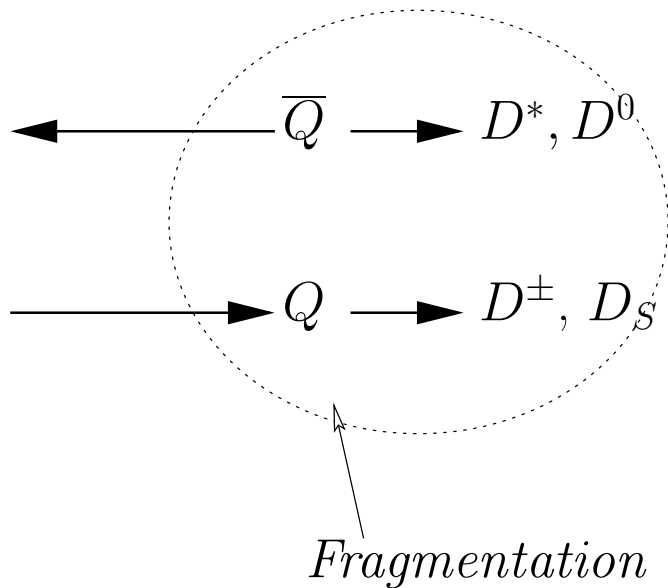

- $f(c \rightarrow H)$  is the fraction of  $c$  quarks ending in a specific hadronic state  $H$  (e.g.  $D^{*\pm}$ ,  $D^0$ , etc.)
- Compare HERA results with  $e^+e^-$  (LEP):

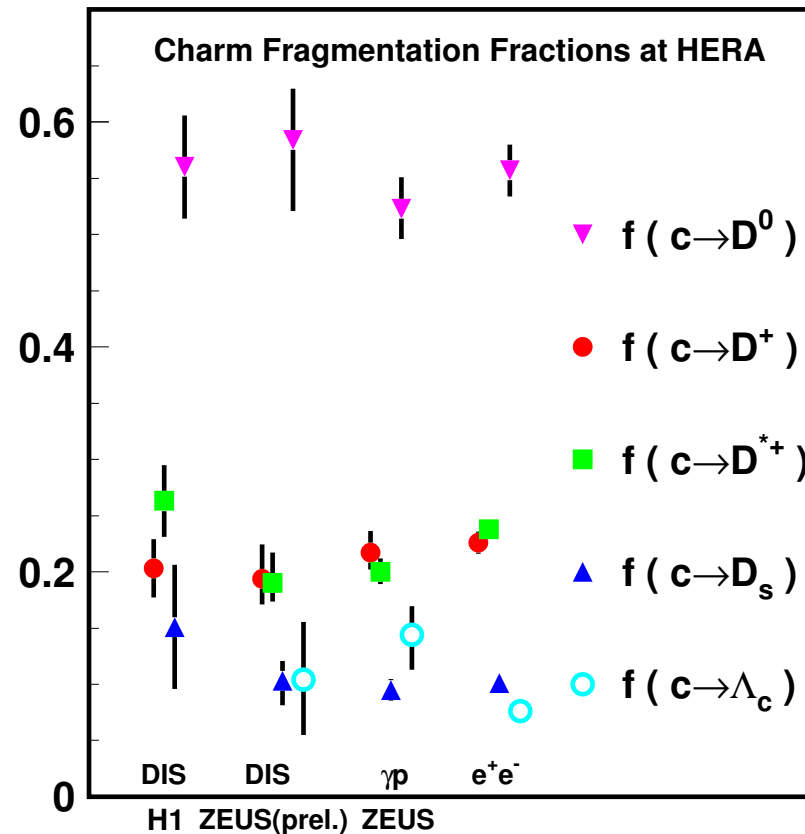

Consistent with the universality assumption of charm fragmentation fractions.

## Ratio of $u/d$ in Charm Fragmentation

$R_{u/d}$  is the ratio of the sum of direct neutral mesons ( $D^0, D^{*0}$ ) production cross sections to the sum of the charged mesons ( $D^{*\pm}, D^\pm$ ) production cross sections

$$R_{u/d} = \frac{c\bar{u}}{c\bar{d}}$$

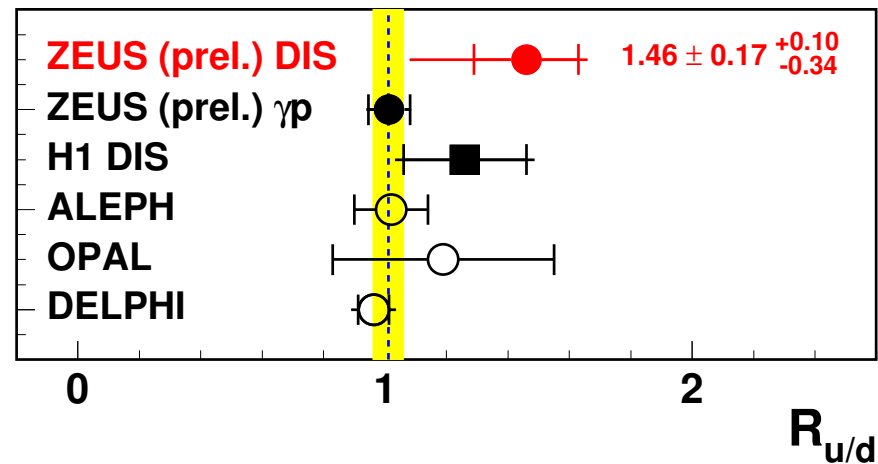

$u$  and  $d$  quarks are produced equally in charm fragmentation.

→ **Strong Isospin Invariance Holds**

## Fraction of $D$ Mesons in Vector State

- The vector to pseudoscalar fraction for charm is:

$$P_V^D = \frac{V}{V + PS}$$

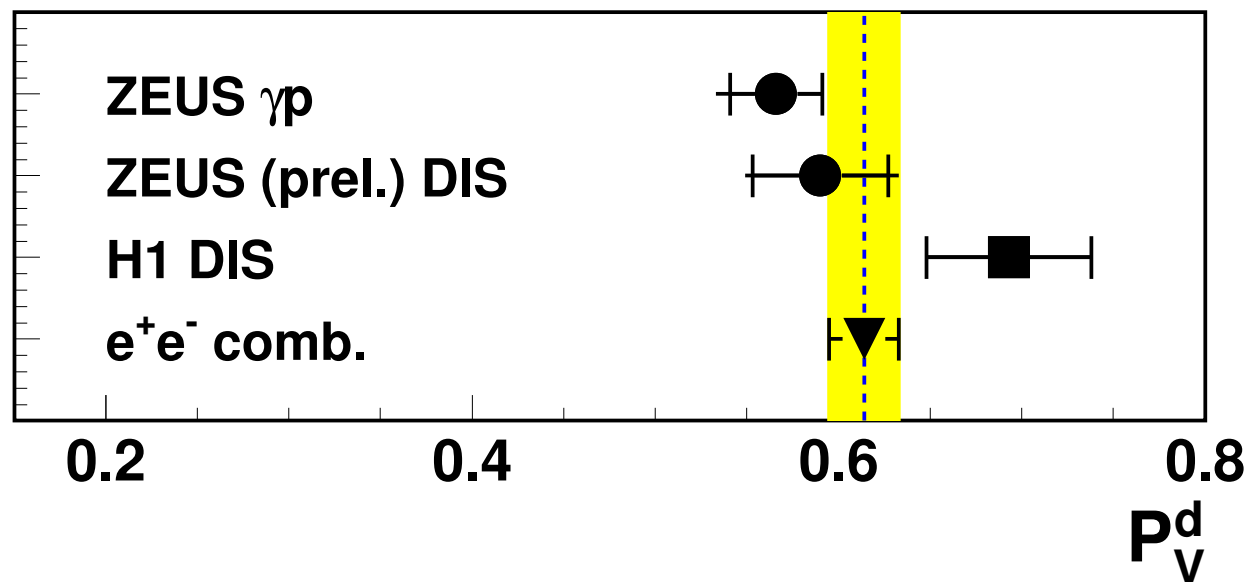

- $P_V^D \neq 0.75$  Simple Spin Counting Does NOT Work with Charm.

---

To summarize fragmentation; the fragmentation fractions, ratio of  $u$  to  $d$ , and the vector to pseudoscalar ratio for  $D$  mesons are consistent with universality.

## Calculations in pQCD

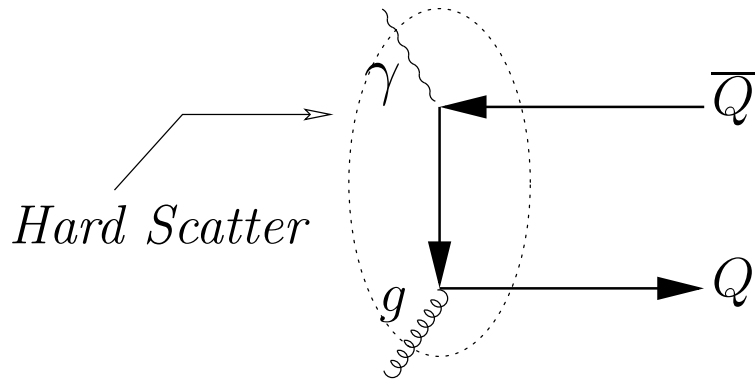

When looking at the hard scattering process, 2 schemes of calculating pQCD are:

### “Massive” Scheme

- $c/b$  massive i.e.  $m_Q \neq 0$
- valid when  $m_Q^2 \approx Q^2$
- Heavy quarks (HQ) NOT active flavours in parton distributions
- HQ produced in the hard scatter, e.g.  $\gamma g \rightarrow Q\bar{Q}$

### “Massless” Scheme

- $c/b$  massless i.e.  $m_Q = 0$
- valid when  $p_T^2 \gg m_Q^2$
- HQ active flavours in parton distribution, i.e. charm and beauty are in the proton
- HQ can be produced in reactions such as  $gQ \rightarrow gQ$

# Charm Jet in Photoproduction

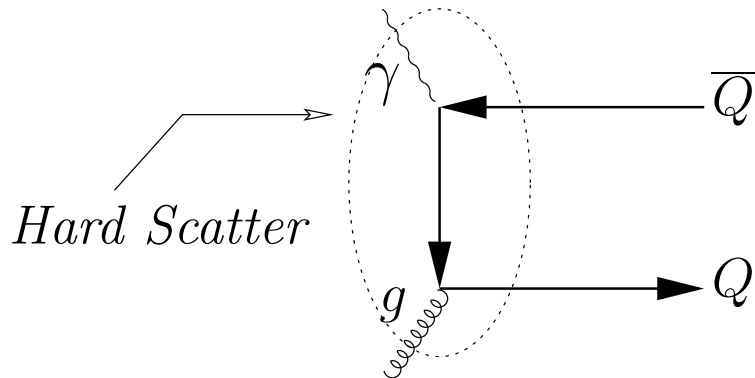

Why study Jets in addition to  $D^*$ s?

- Effects from fragmentation are reduced
- Jets are a good approximation of outgoing partons

The angle in the transverse plane between  $D^*$  and the other jet is  $\Delta\phi$ .

- To leading order (LO) jets should be back to back
- Large fraction of jets are not back to back indicating contributions from higher order QCD radiation.

At  $\Delta\phi < 120$  NLO predicts a smaller cross section than is observed.

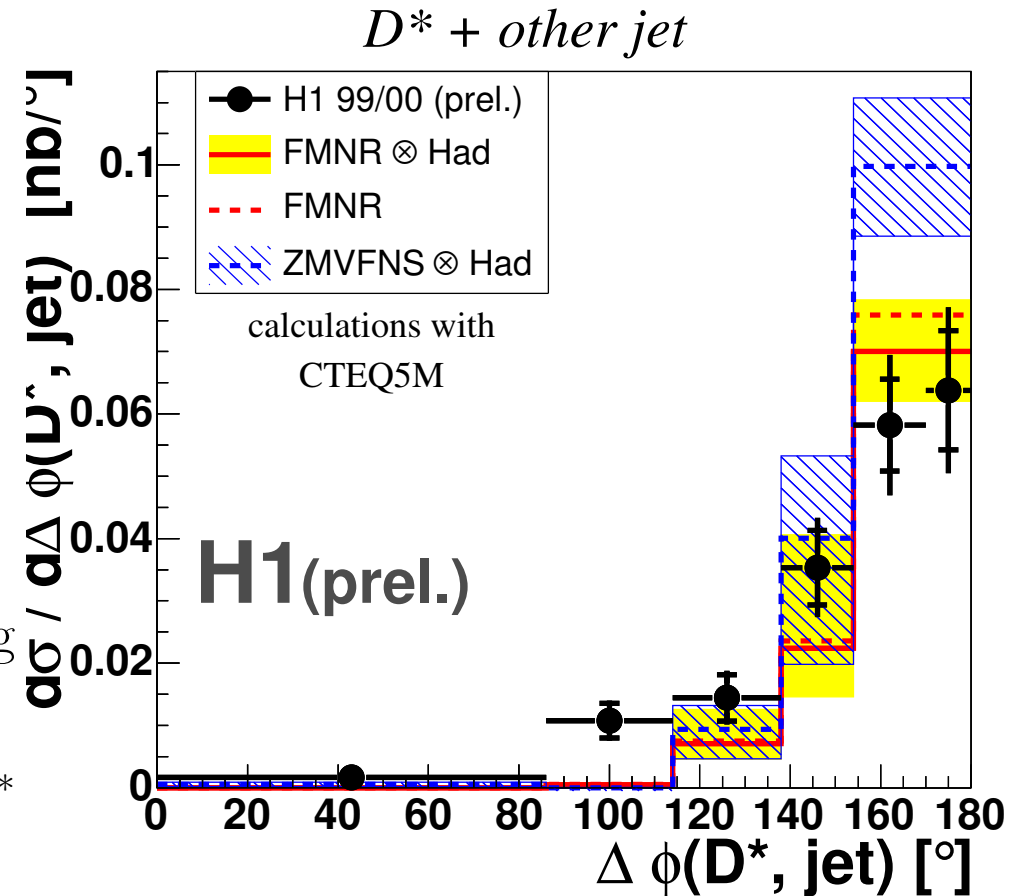

Made with low  $p_T$  Jets.

# Charm Dijets in Photoproduction

Comparison with higher  $E_T$  Jets:

- Dijet mass ( $M^{jj}$ ) well described by the massive NLO QCD prediction
- $\Delta\phi^{jj}$  and  $(p_T^{jj})^2$  show a large deviation from NLO at low  $\Delta\phi^{jj}$  and at high  $(p_T^{jj})^2$
- These regions are expected to be sensitive to higher order effects

(ZEUS 98-00 data, the jet energy scale uncertainty indicated in yellow)

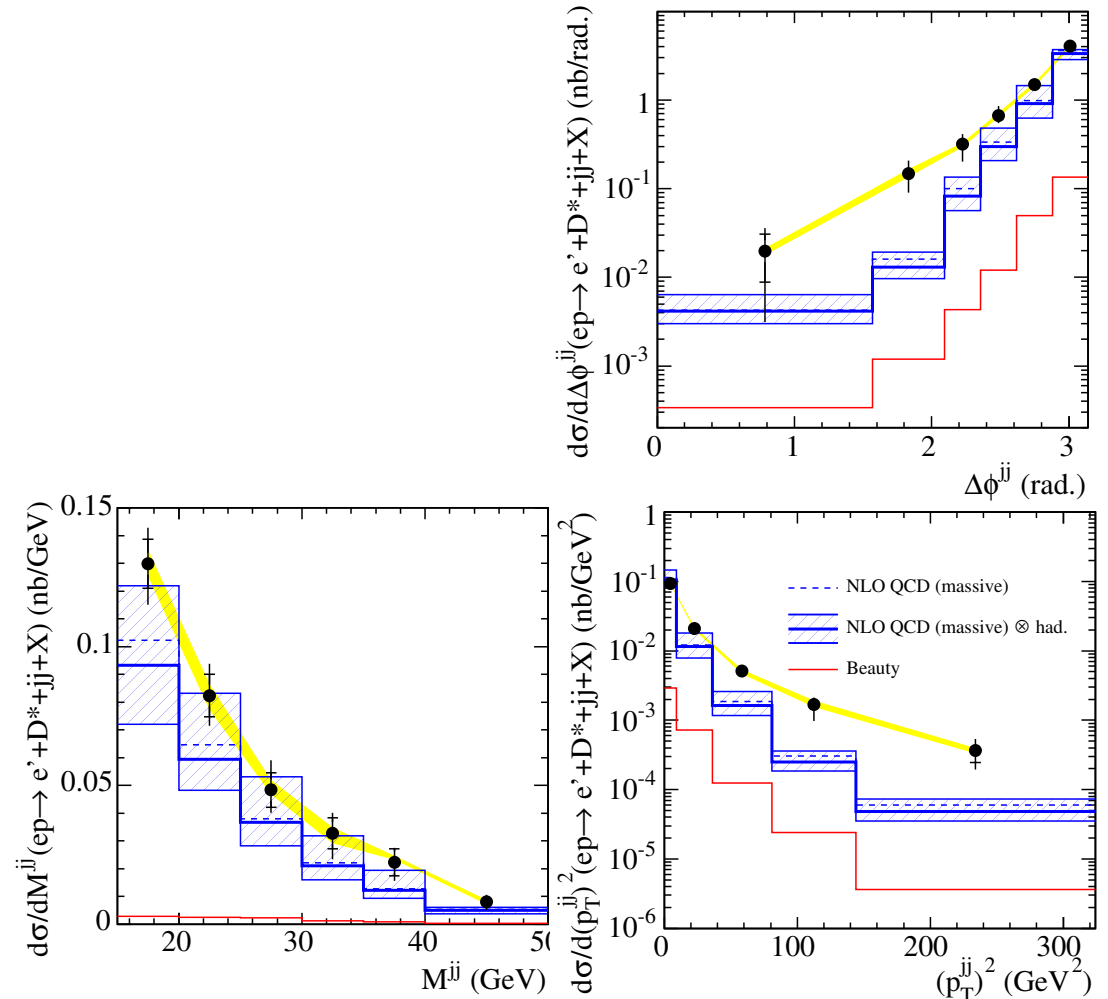

Good agreement of data to NLO except in phase space regions where higher orders are enhanced

# $D^{*\pm}$ Dijets in Photoproduction

ZEUS

- Jets are considered  $D^{*\pm}$  tagged when  $\Delta R < 0.6$  where 
$$\Delta R = \sqrt{(\eta^{Jet} - \eta^{D^{*\pm}})^2 + (\phi^{Jet} - \phi^{D^{*\pm}})^2}$$
- The upper cross sections compare NLO QCD in a massive scheme to data
- The lower is a massless scheme comparison to data

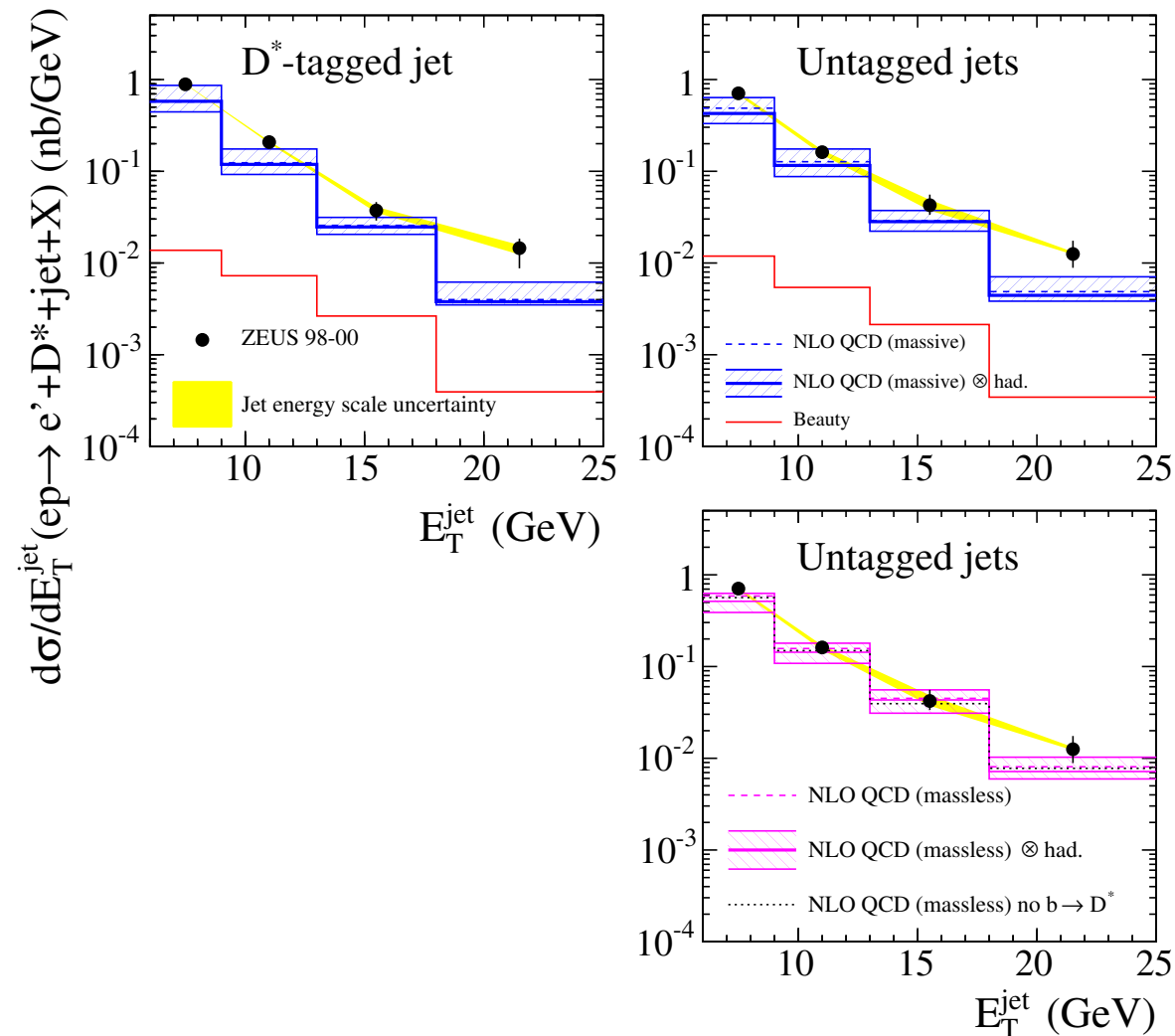

Jets summary:

**Both massive and massless pQCD give a good description of the data**

## Tagging Beauty via Muons

Now onto beauty. How is beauty measured?

- The process  $ep \rightarrow ebb\bar{X} \rightarrow ejj\mu X$ , where beauty decays via  $b \rightarrow \mu X$  is used to tag beauty
- Due to large beauty mass, muons will have a high  $p_t$  relative to the beauty jet direction ( $p_T^{Rel}$ )
- Due to the long  $b$  lifetime, the muon will have a large impact parameter ( $\delta$ )
- Impact parameters are signed as seen below:

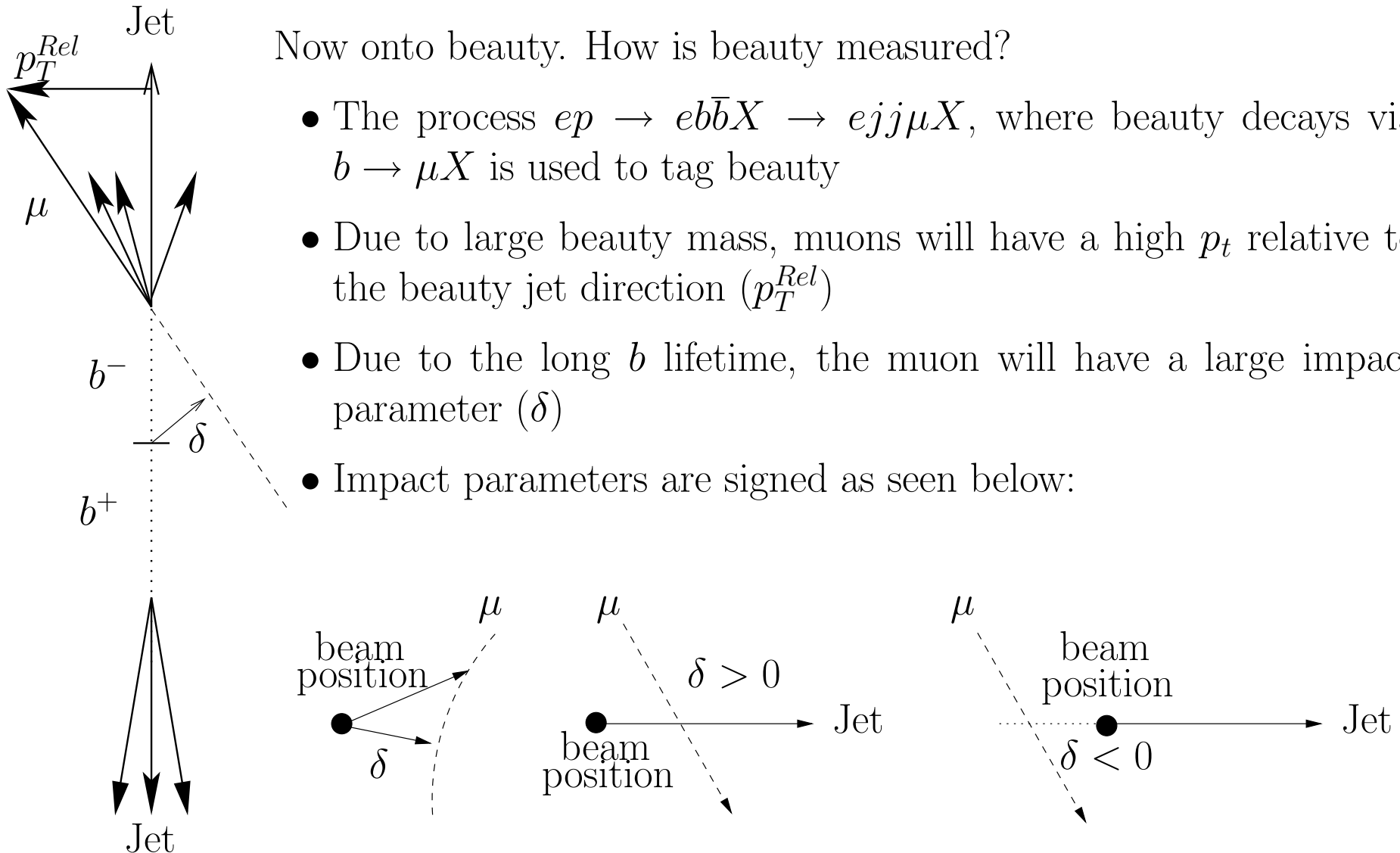

# Beauty from $p_T^{Rel}$ and Impact Parameters

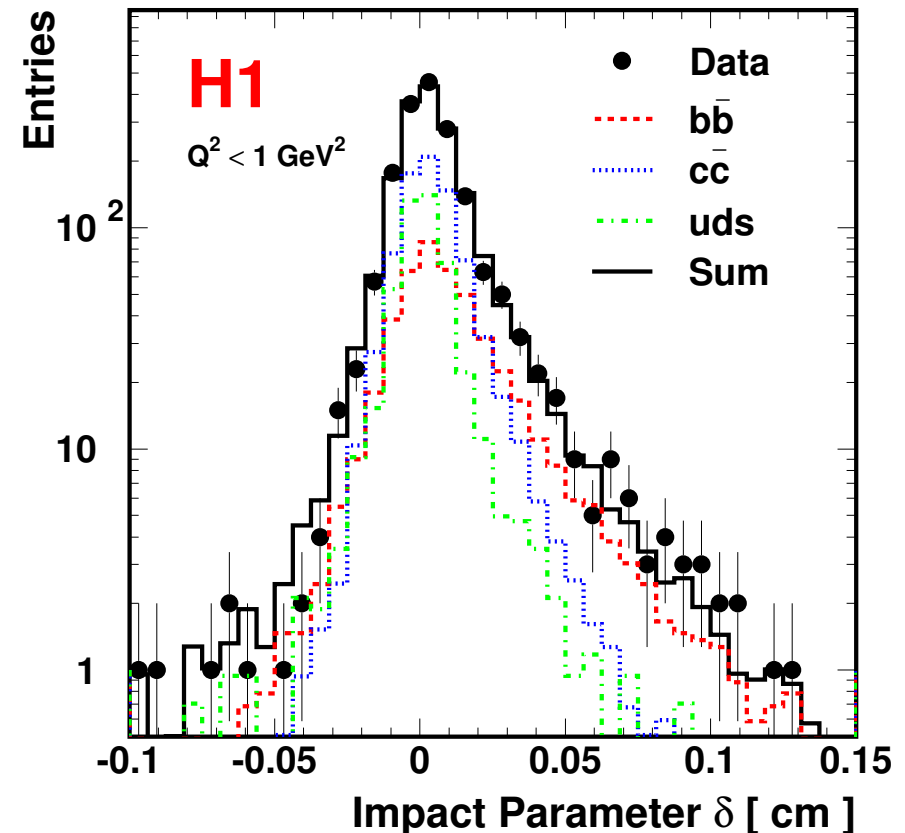
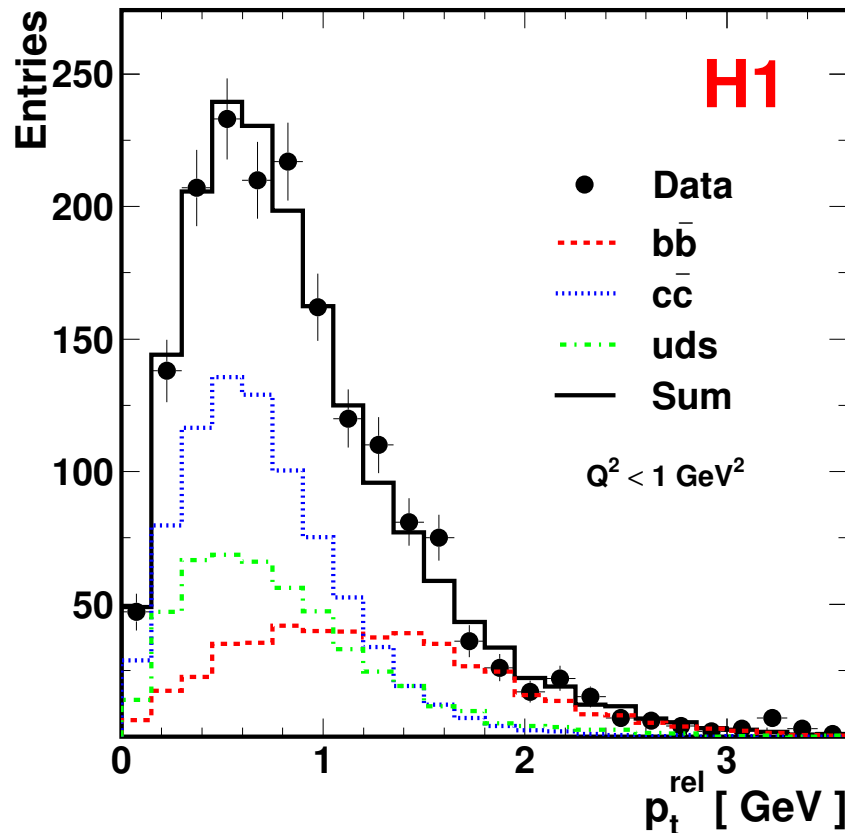

- The fractions of  $b$ ,  $c$ , and light flavours (LF) are determined from a likelihood fit to the 2D distributions  $(p_T^{Rel}, \delta)$
- At higher  $p_T^{Rel}$ , the contribution from beauty falls off less rapidly than that of the LF
- The same beauty to LF fall off feature occurs for higher positive impact parameters
- ( $\delta$  LF  $\approx$  symmetric about zero)

# Photoproduction with $\mu + \text{Jets}$

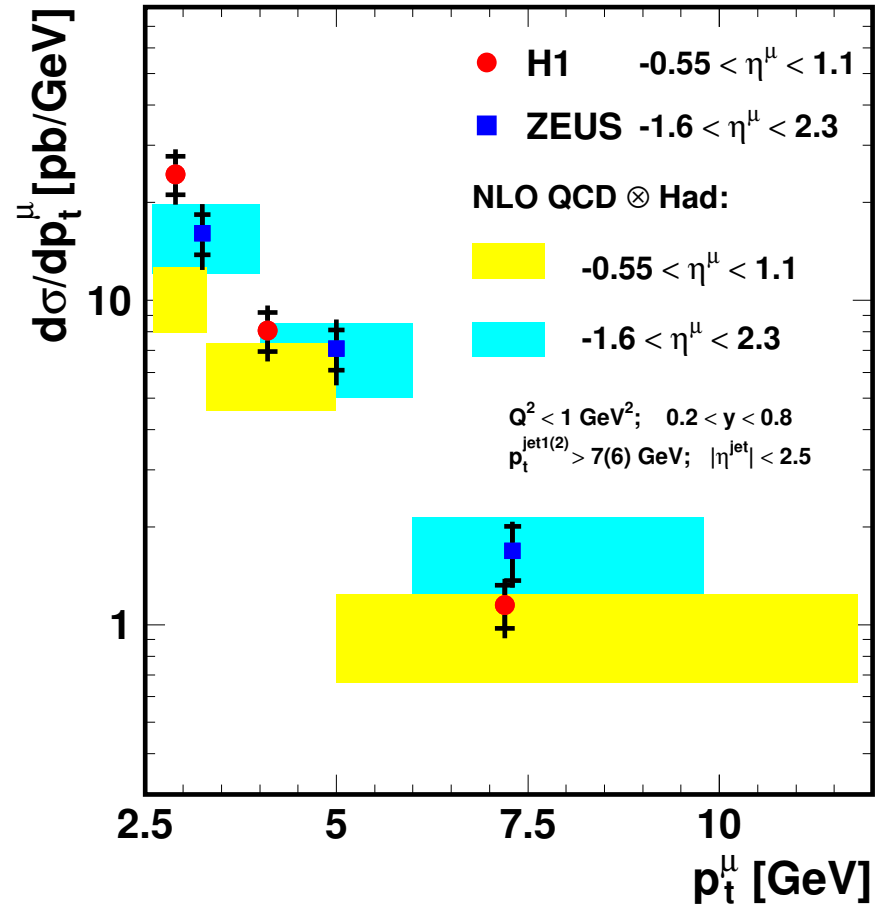
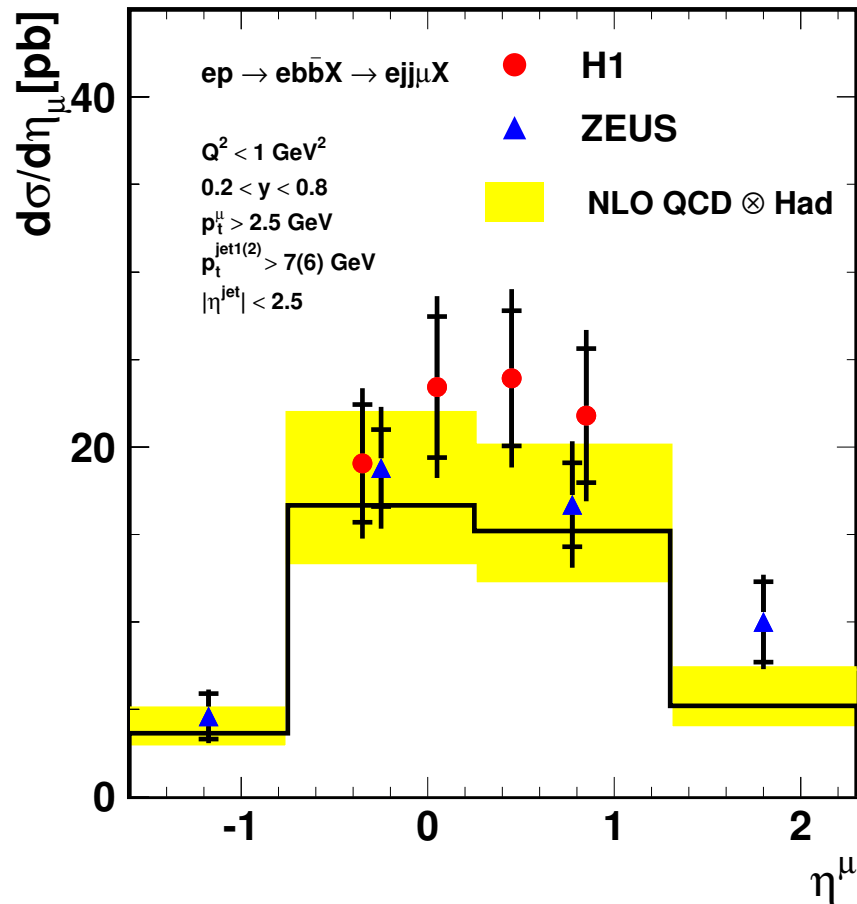

Agreement between H1 and ZEUS

- ZEUS: Good agreement with NLO pQCD
- H1: Excess data/NLO at low  $p_T^\mu$

## Photoproduction $\mu + \text{Jets}$

The  $p_T$  cross sections for muons created in the process  $ep \rightarrow e b \bar{b} X \rightarrow e j j \mu X$  is shown:

- This measurement utilizes the added ZEUS silicon Micro Vertex Detector (MVD)
- In good agreement with ZEUS HERA I data, and to the NLO QCD prediction from FMNR
- First beauty result from HERA II
- Measurement made with only 20% of present data

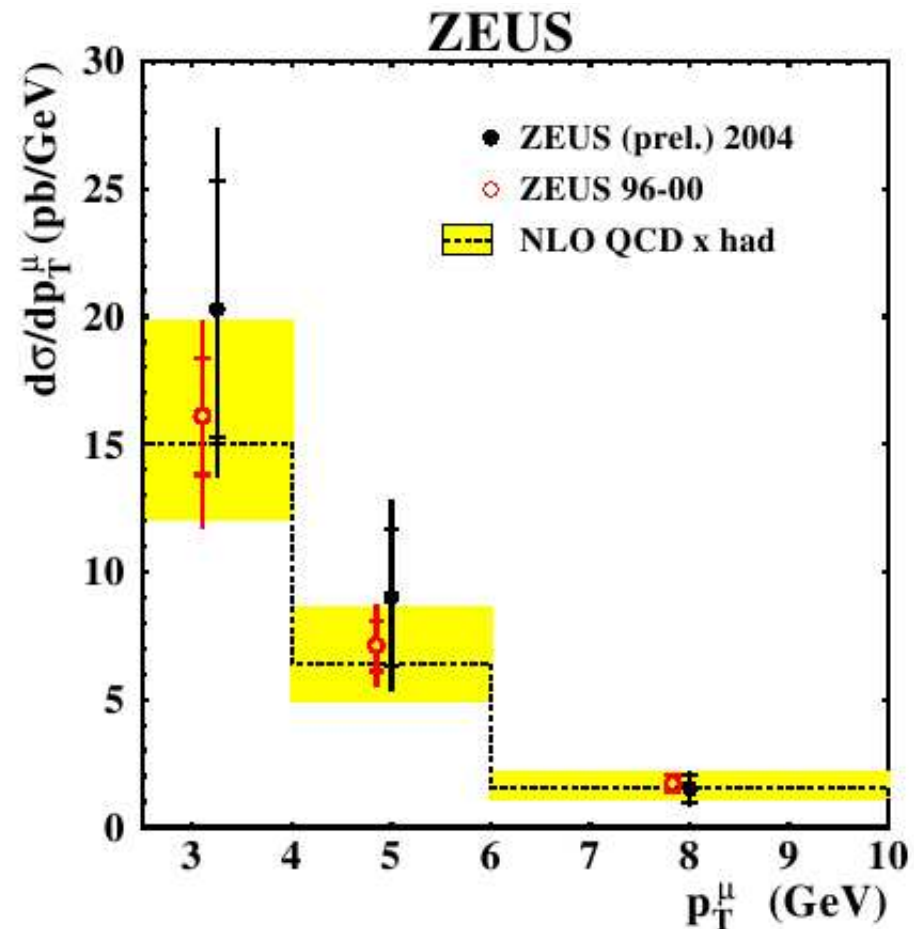

**Much more to come!**

## Inclusive Lifetime Tag

An inclusive method to measure beauty and charm utilizes the significance of the signed impact parameter  $S = \delta/\sigma(\delta)$ .

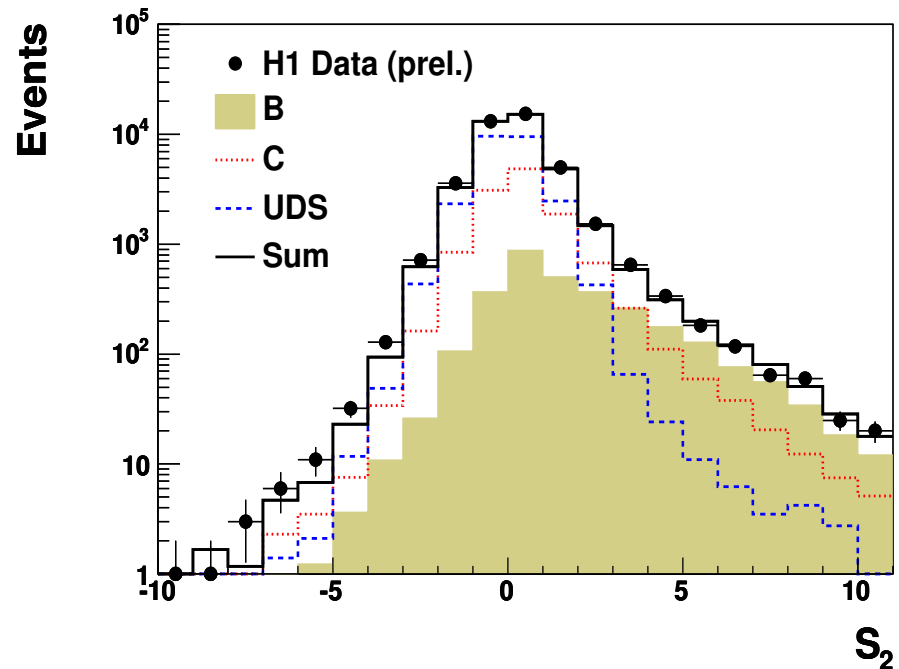
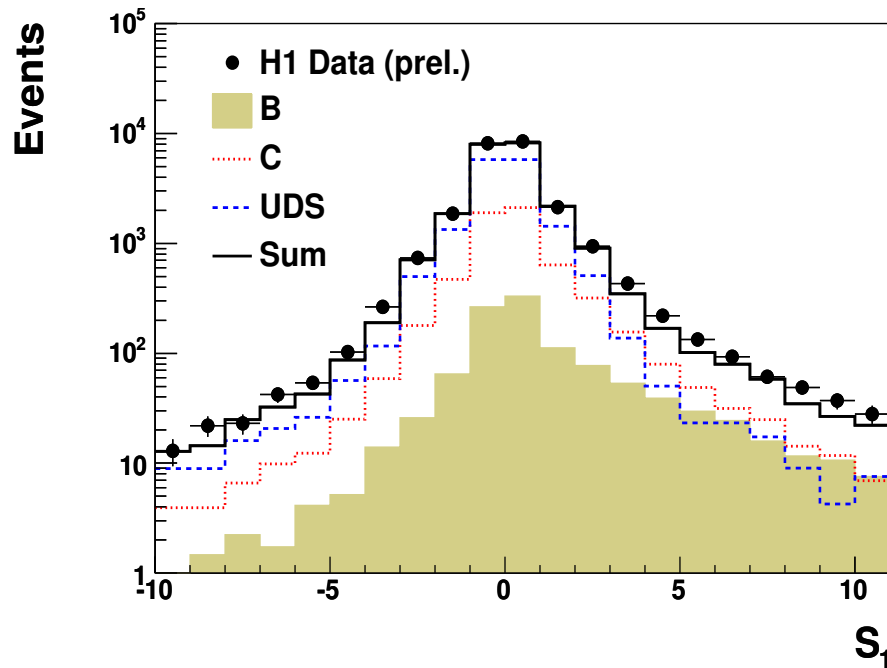

- The (positive) tail of the 1st most significant track ( $S_1$ ) shows the charm to LF ratio increase
- Now the (positive) tail of the  $S_2$  shows the beauty to LF ratio increase

Beauty and charm cross sections are obtained from likelihood fits to data

## Extraction of $F_2^{\bar{Q}Q}$

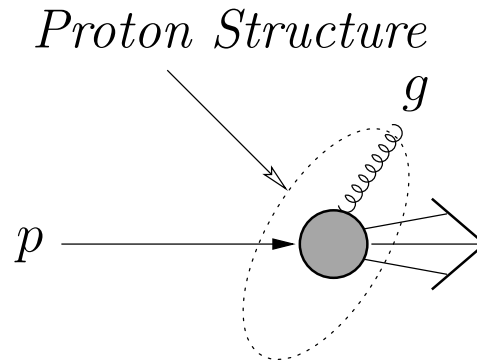

$F_2^{\bar{Q}Q}$  is extracted from the charm/beauty double differential cross sections:

$$\frac{d^2\sigma^{Q\bar{Q}}(x, Q^2)}{dx dQ^2} = \frac{2\pi\alpha^2}{xQ^4} \left( [1 + (1 - y)^2] F_2^{Q\bar{Q}}(x, Q^2) - y^2 F_L^{Q\bar{Q}}(x, Q^2) \right)$$

- $F_L$  only significant at large  $y$
- $F_2$  depends on  $Q^2$  only because gluons are present in the proton
- Previous measurements used  $D^*$  cross sections to determine  $F_2^{\bar{c}c}$
- New (H1)  $F_2^{\bar{c}c}$  measurement uses inclusive lifetime tag
- $F_2^{\bar{b}b}$  uses inclusive lifetime tag measurements

$$F_2^{\bar{c}c}$$

- QCD calculations fit the data reasonably well
- NNLO calculations now available
- scaling violation

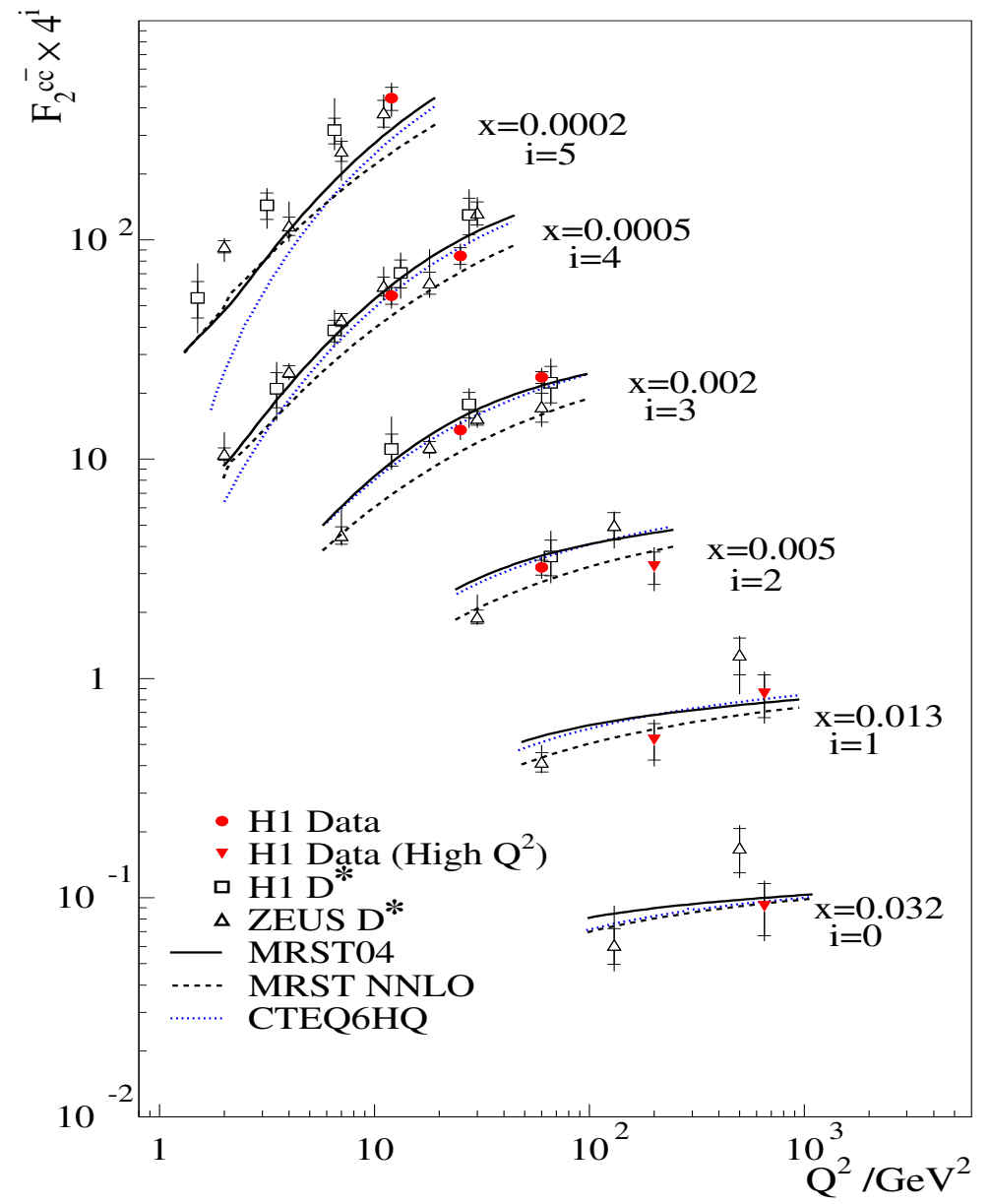

$$F_2^{\bar{c}c} / F_2$$

- $F_2^{\bar{c}c}$  increases with  $Q^2$  for same  $x$
- Contributions from  $F_2^{\bar{c}c}$  can be as high as 30%
- Good description by NLO QCD calculation

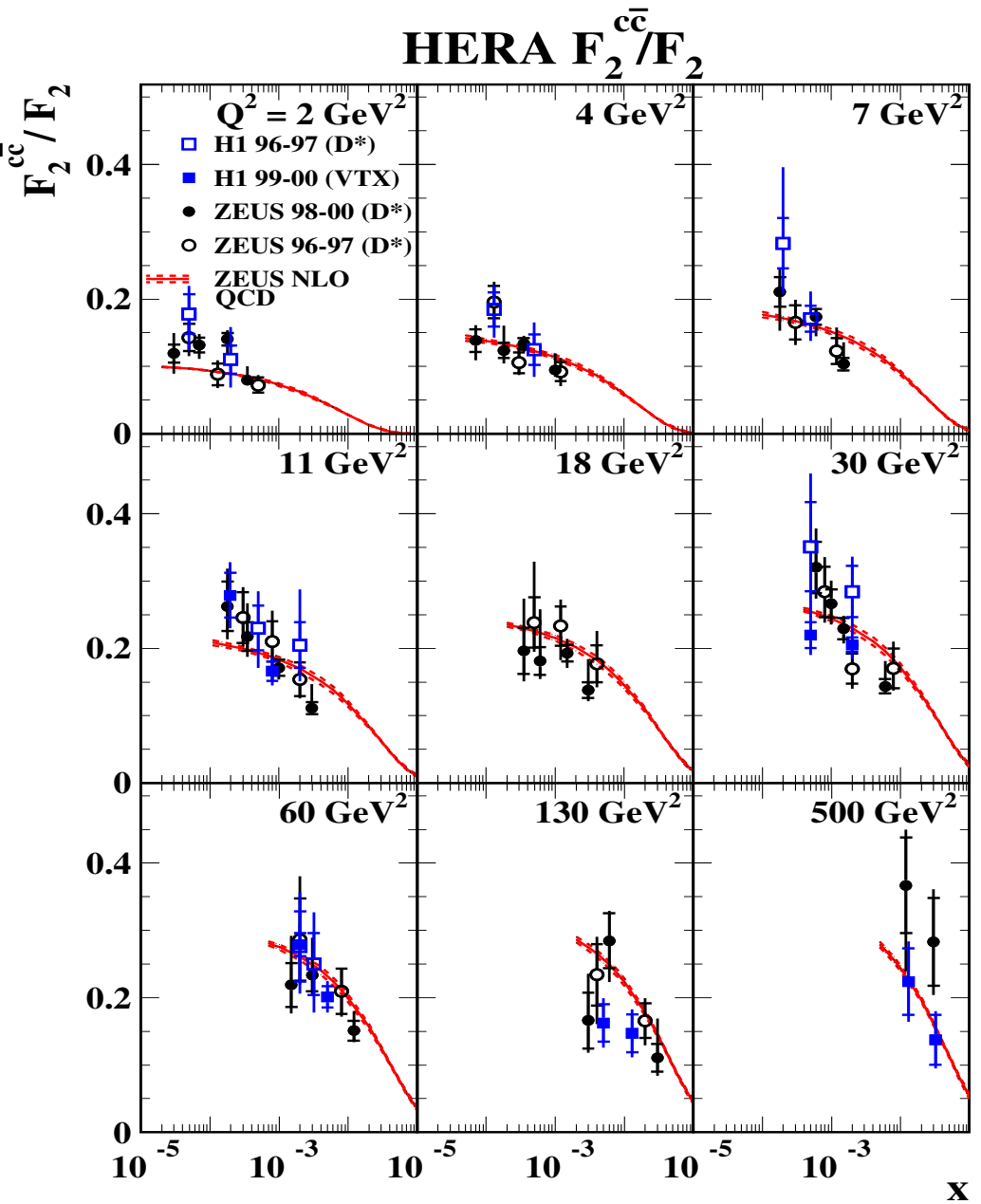

$$F_2^{\bar{b}b}$$

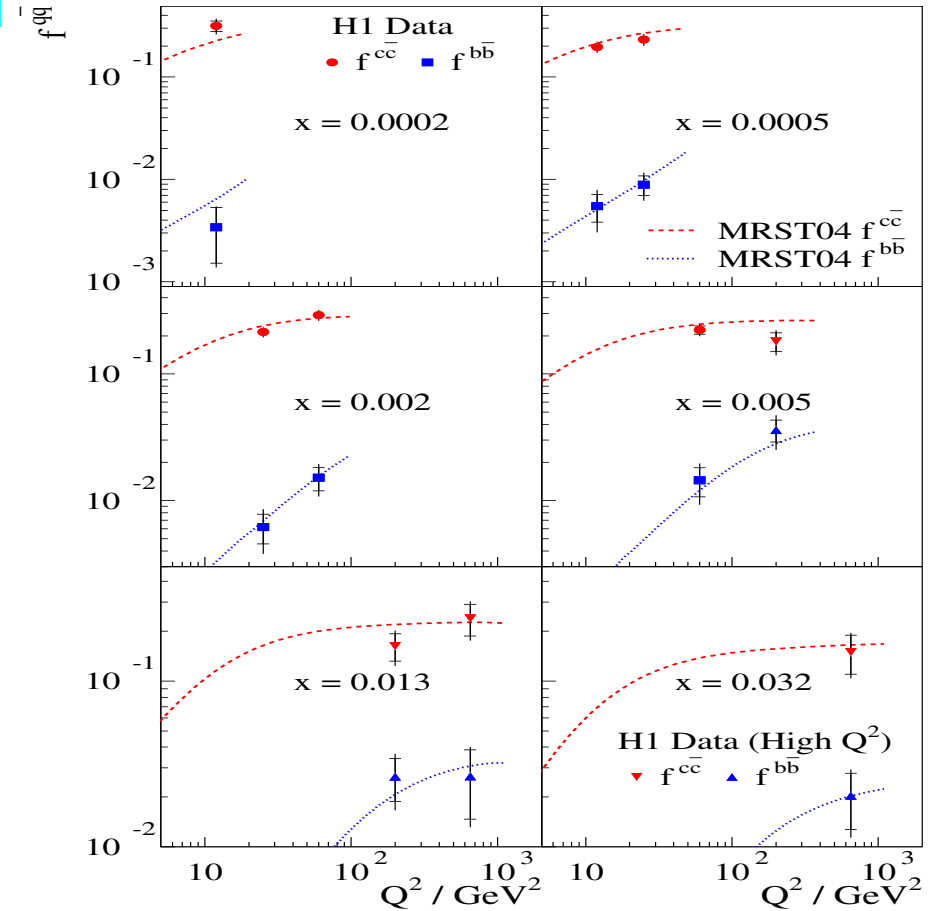
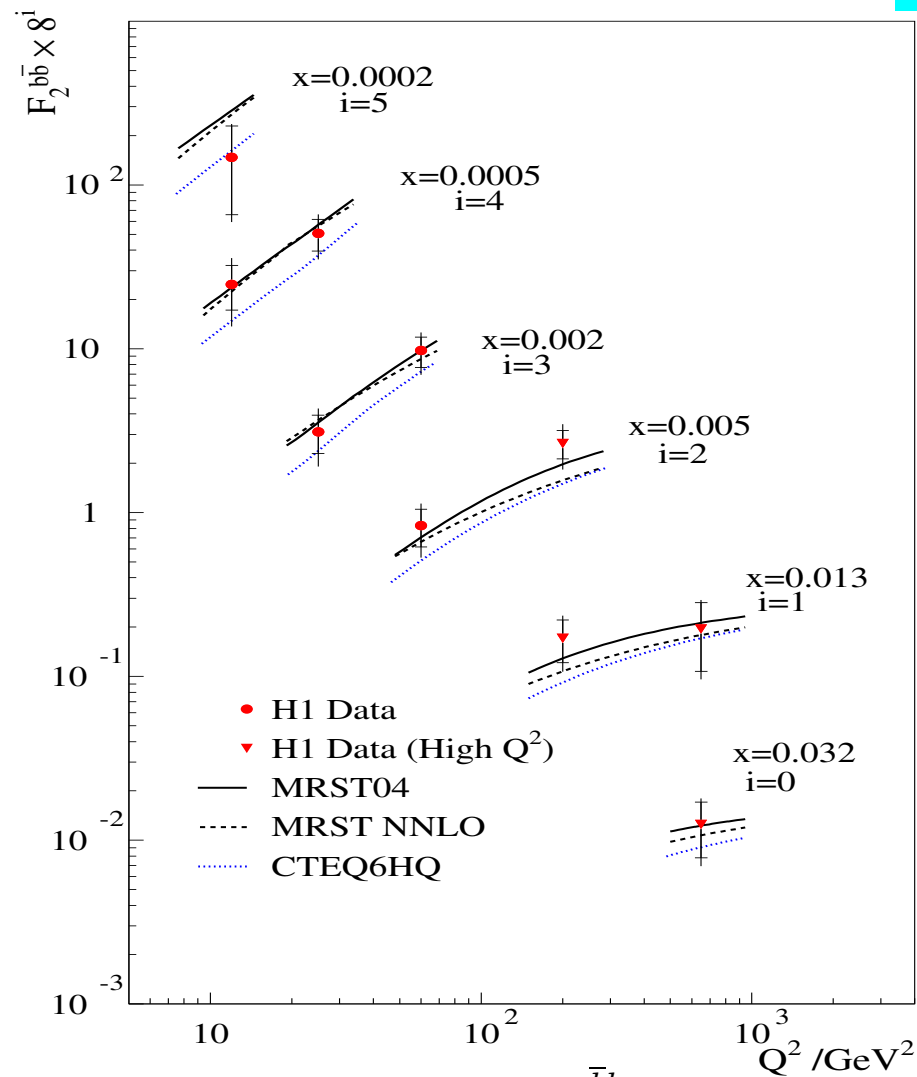

Beauty contributes a small fraction to the total  $F_2$

- First measurement of  $F_2^{\bar{b}b}$
- Improved precision expected from HERA II
- Compared to NNLO as well

## Summary

- HERA results consistent with universality of charm fragmentation
- Cross sections reasonably well described by NLO pQCD
  - Higher order calculations needed in some regions
- Both  $c$  and  $b$  contribution to  $F_2$  have been measured

## Outlook

- HERA II luminosity exceeds HERA I, 160  $\text{pb}^{-1}$  thus far, 240  $\text{pb}^{-1}$  to come (optimistically 500  $\text{pb}^{-1}$  by end of running in 2007)
- Most HERA data not yet analyzed
- Many more results from HERA to come!

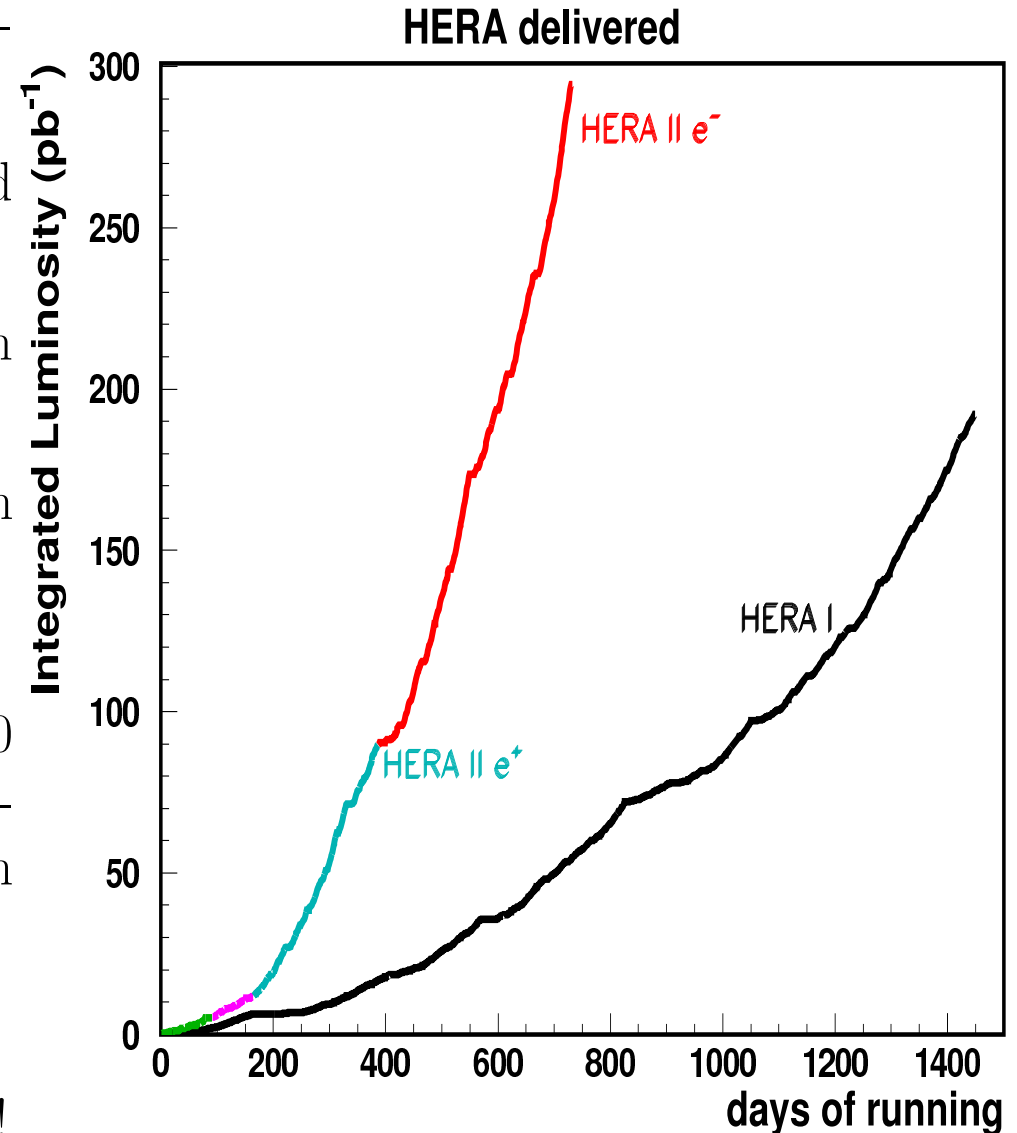

## Combined Fit of $p_T^{Rel}$ and $\delta$

ZEUS measured similar  $p_T^{Rel}$  and  $\delta$  distributions.

- $p_T^{Rel}$  is plotted in bins of  $\delta$
- Minimization of  $\chi^2$  fits resulted in fractions  $f_b$  and  $f_c$
- $\chi^2 = \frac{\sum_i (N_i^{data} - N_i^{fit})^2}{D.O.F}$
- where  $N_i^{fit} = \frac{f_b N_i^b + f_c N_i^c + f_{LF} N_i^{LF}}{f_b + f_c + f_{LF}}$
- The three contours indicate regions of 68% probability that the charm and beauty fractions are  $f_b = 0.166 \pm 0.026$  and  $f_c = 0.518 \pm 0.098$
- Three MC samples (for b, c, and LF) were adjusted in MC to reproduce the data

