

Multijet production at HERA

Mara Senghi Soares

Universidad Autónoma de Madrid

On behalf of H1 and ZEUS Collaborations

Contents:

- Multijet production at low- x in DIS
- Angular correlation between jets
- Multijet production in charged current DIS
- Three and four-jet final states in photoproduction
- Minijets in DIS

EPS 2007

20/July/2007 - Manchester - UK

Multijet at low- x

- Parton dynamics (low- x_{bj})

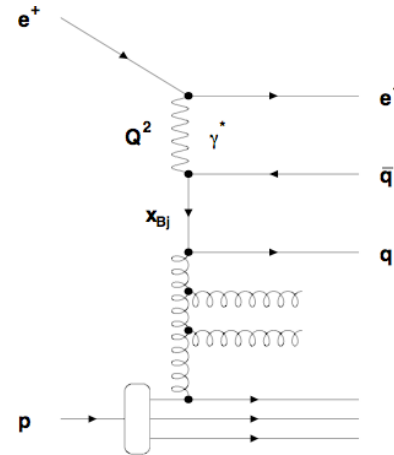

- . In general, at high Q^2 , high x , DGLAP equation (**partons E_T ordering**) describes the data
- . At lower x , parton emission increases, DGLAP approach may not work
- . Jet cross sections at low- x : sensitive to unordered gluon radiation
- . Good ground to test the limit of validity of DGLAP

*** See next talk by Guenter Grindhammer ***

Multijet at low-x

H1 Collaboration - Event Selection:

$0.1 < y < 0.7$ $4 < Q^2 < 80 \text{ GeV}^2$
 $10^{-4} < x < 10^{-2}$ **At least 3 jets with**
 $E_{\text{t jet1}} > 4 \text{ GeV}$ $E_{\text{t jet2}} + E_{\text{t jet3}} > 9 \text{ GeV}$
 $-1 < \eta^{\text{lab}} < 2.5$, one of them $-1 < \eta^{\text{lab}} < 1.3$

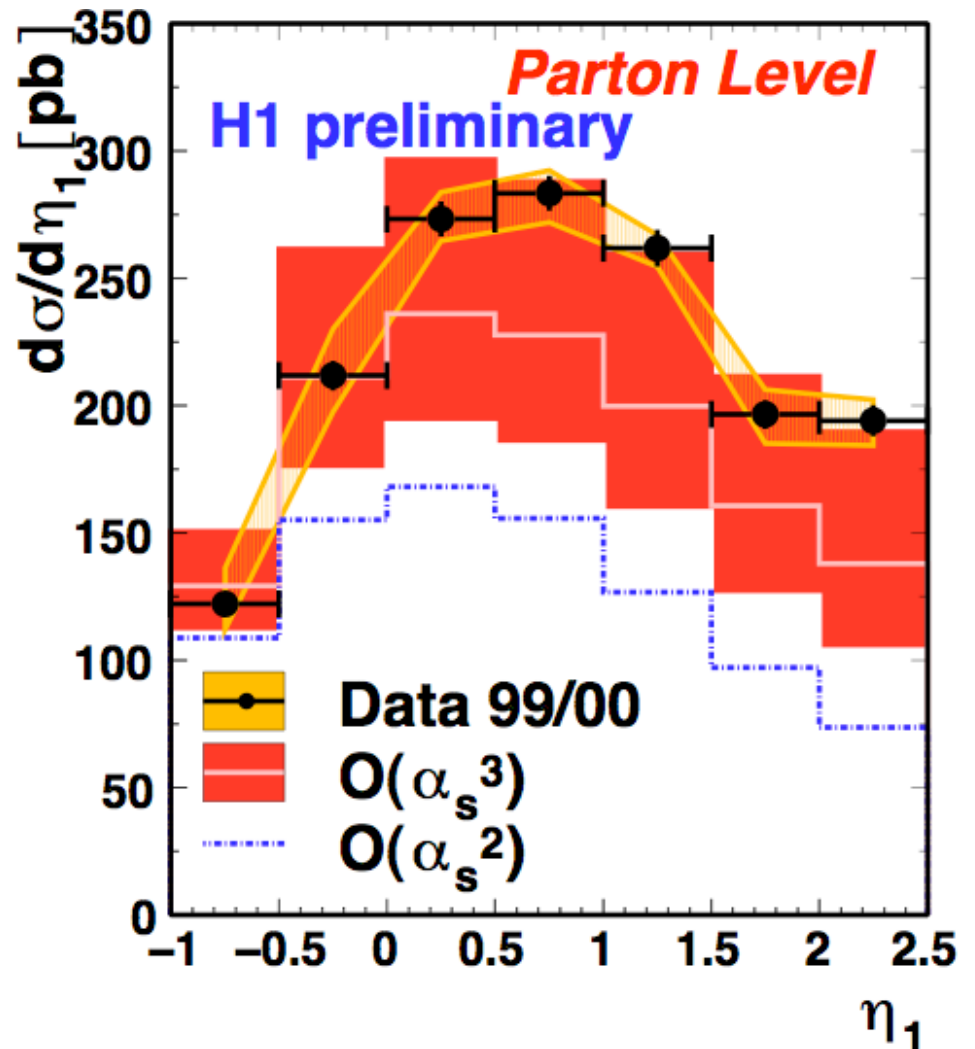
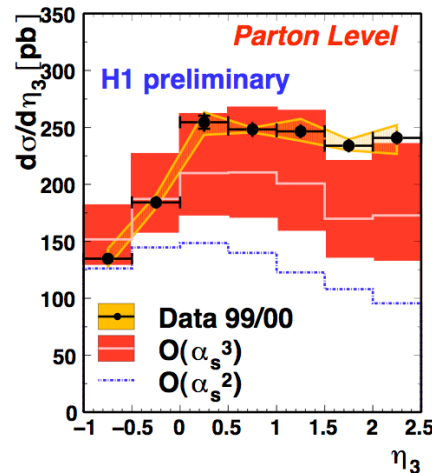
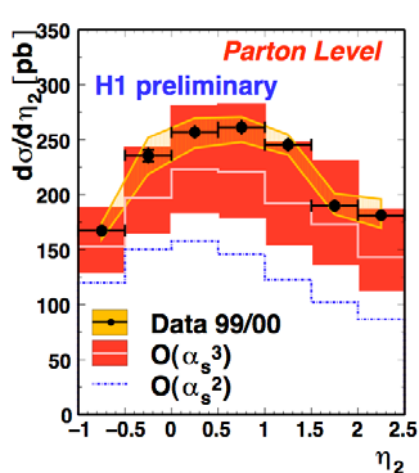

*** Description of the data pretty much improved with NLO ***

Multijet at low- x

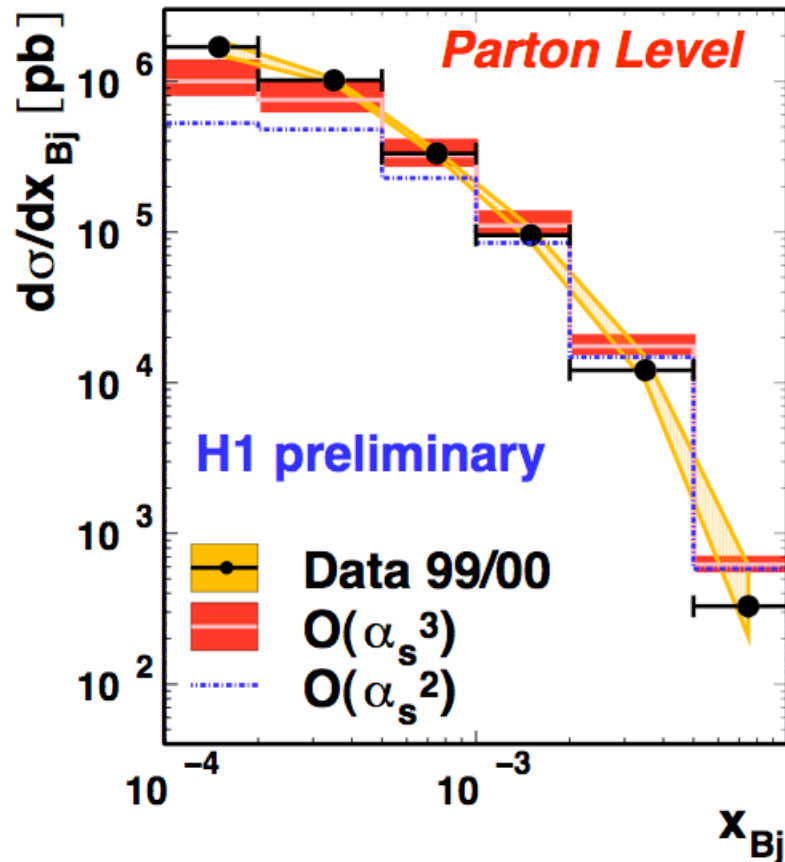

$O(\alpha_s^3)$ calculation

(as in NLOjet++ program)

gives very good description of the data

Exception at very low- x
(see next talk)

Multijet at low-x

ZEUS Collaboration

Event selection:

$$0.1 < y < 0.6 \quad 10 < Q^2 < 100 \text{ GeV}^2$$

$$10^{-4} < x < 10^{-2} \quad \text{2 or 3 jets with}$$

$$E_{\perp}^{\text{jet1}} > 7 \text{ GeV} \quad E_{\perp}^{\text{jet2(3)}} > 5 \text{ GeV}$$

$$-1 < \eta^{\text{lab}} < 2.5$$

Variables:

$|\Sigma p^{\text{jet1,2}}_{\perp, \text{HCM}}|$ = transverse component of the vector sum of the two jet momenta with the highest hadronic center of mass E_{T}

$|\Delta\Phi^{\text{jet1,2}}_{\perp, \text{HCM}}|$ = azimuthal separation btw the same two jets

Multijet at low- x

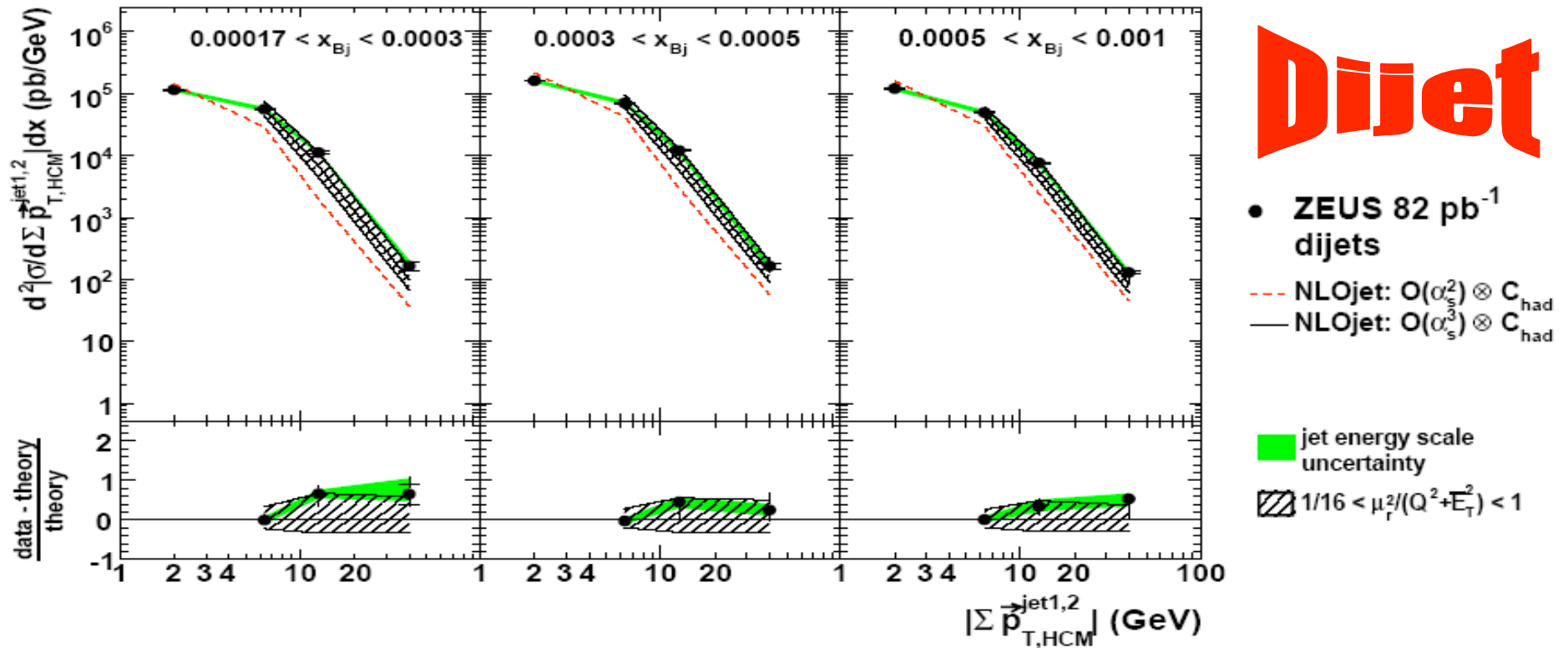

Data well described by pQCD calculations when NLO correction is included

Multijet at low-x

Trijet

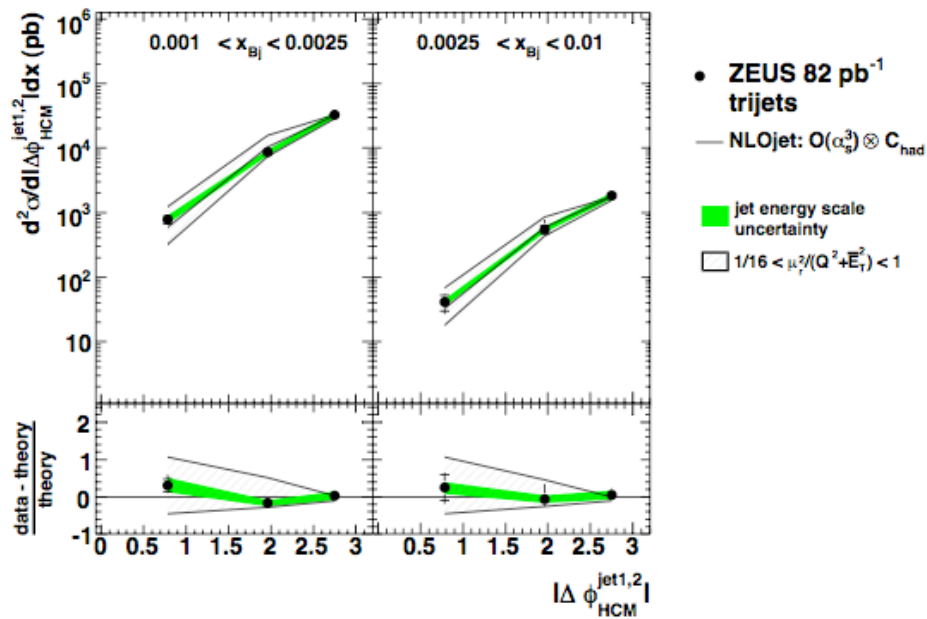
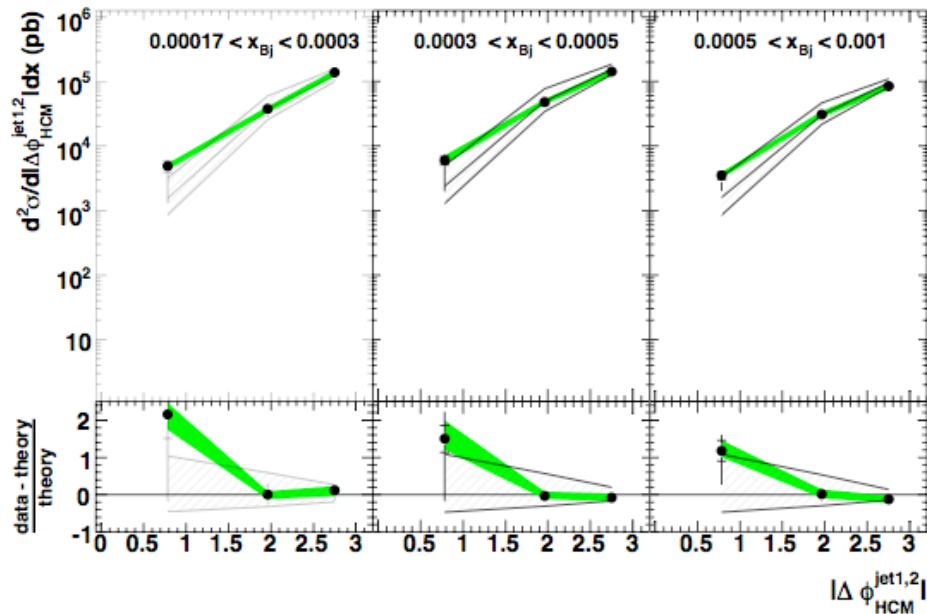

Data well described
by pQCD

Angular correlations

- Three jet events allow the study of the underlying gauge structure of QCD
- The dynamics of a gauge theory such as QCD is determined by the colour factors C_A , C_F , T_F

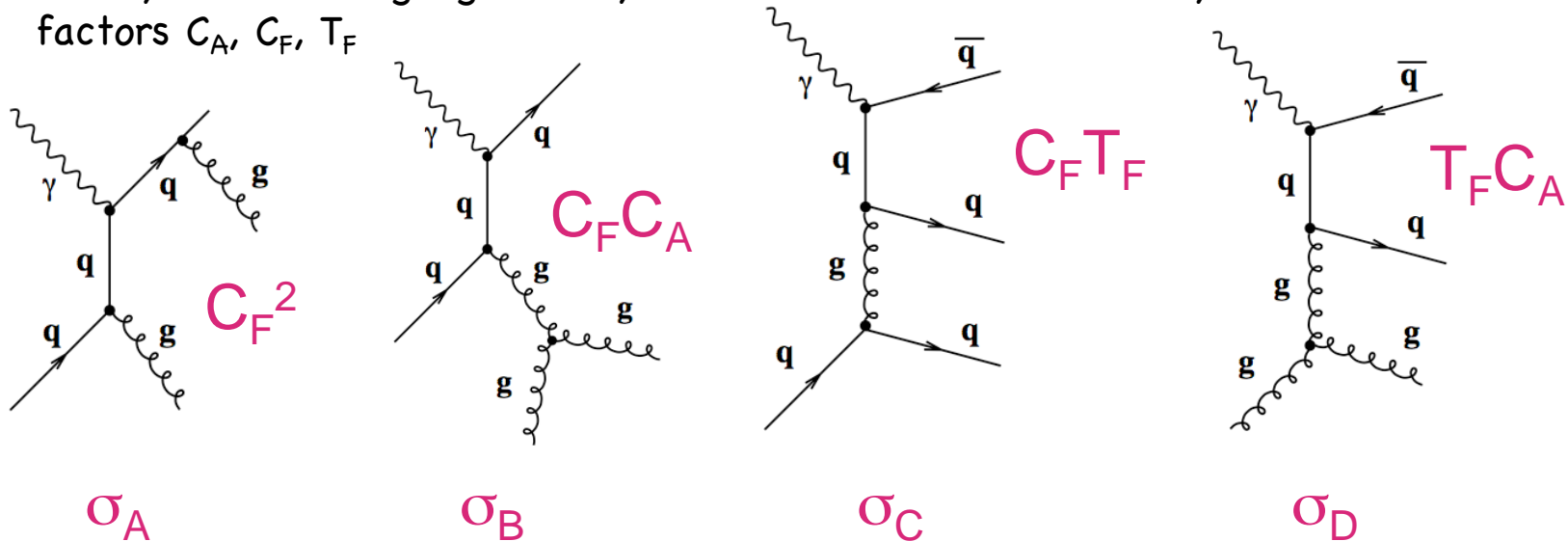

$$\sigma_{ep \rightarrow 3\text{jets}} = C_F^2 \sigma_A + C_F C_A \sigma_B + C_F T_F \sigma_C + T_F C_A \sigma_D$$

Angular correlations

- Angular correlations between jets in DIS can be defined providing sensitivity to the different colour configurations

θ_H = angle btw planes determined by highest transverse energy jet and beam line and by the two lowest transverse energy jets

α_{23} = angle btw the two lowest transverse energy jets

η_{\max} = pseudorapidity of the most forward jet

$$\cos(\beta_{\text{KSW}}) = \cos[1/2(\angle[(p_1 \times p_3), (p_2 \times p_B)] + \angle[(p_1 \times p_B), (p_2 \times p_3)]]$$

(p_B = unity vector in the beam direction)

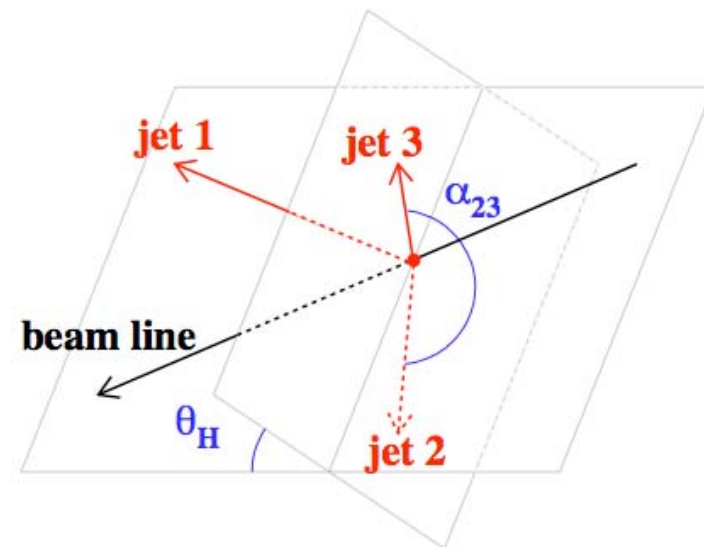

Angular correlations

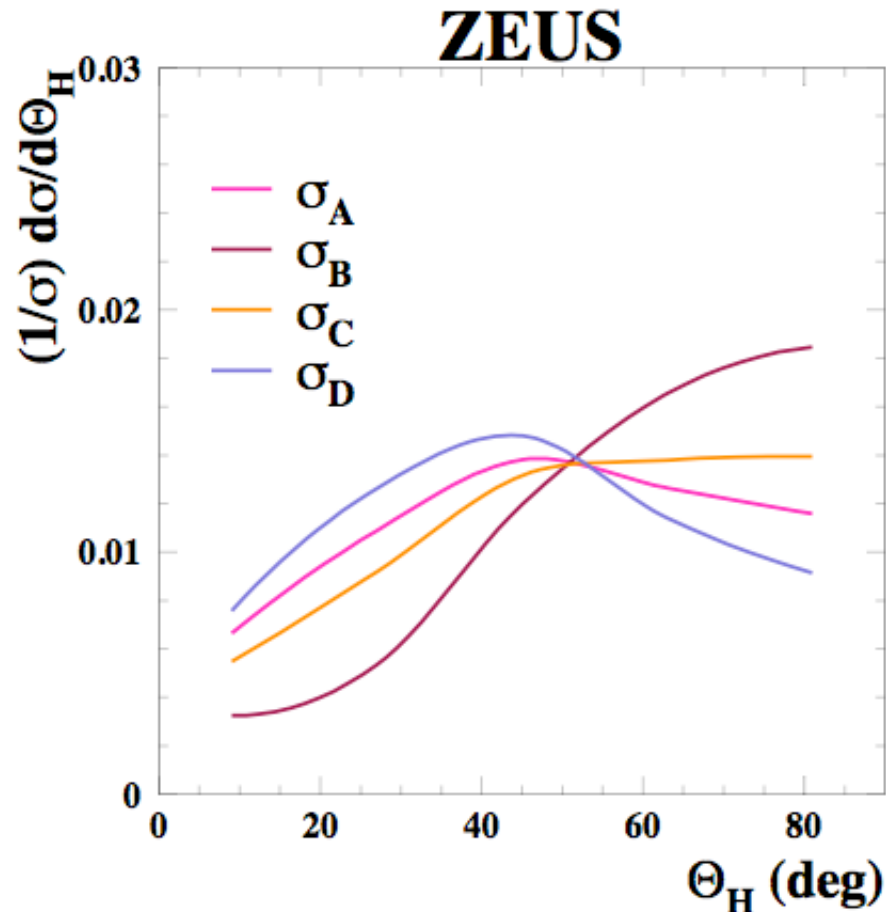

Different shapes for each contribution

The same for the other angular correlations

Data can potentially distinguish different colour configurations

Angular correlations

ZEUS - Event selection:

- . $Q^2 > 125 \text{ GeV}^2$
- . $|\cos\gamma_h| < 0.65$
- . 3 jets (kt cluster, Breit frame)
with
 - $-2 < \eta_B^{\text{jet}} < 1.5$
 - $E_{t,B}^{\text{jet } 1} > 8 \text{ GeV}$
 - $E_{t,B}^{\text{jet } 2} > 5 \text{ GeV}, E_{t,B}^{\text{jet } 3} > 5 \text{ GeV}$

- Compare data to:
 - . SU(3) prediction (QCD):
 - ✓ $C_A/C_F = 9/4$ $T_F/C_F = 3/8$
 - . An abelian gluon model (no gluon self coupling) based on $U(1)^3$ predicts
 - ✓ $C_A/C_F = 0$ $T_F/C_F = 3$
 - . A non-abelian model based on $SO(3)$ predicts
 - ✓ $C_A/C_F = 1$ $T_F/C_F = 1$

Angular correlations

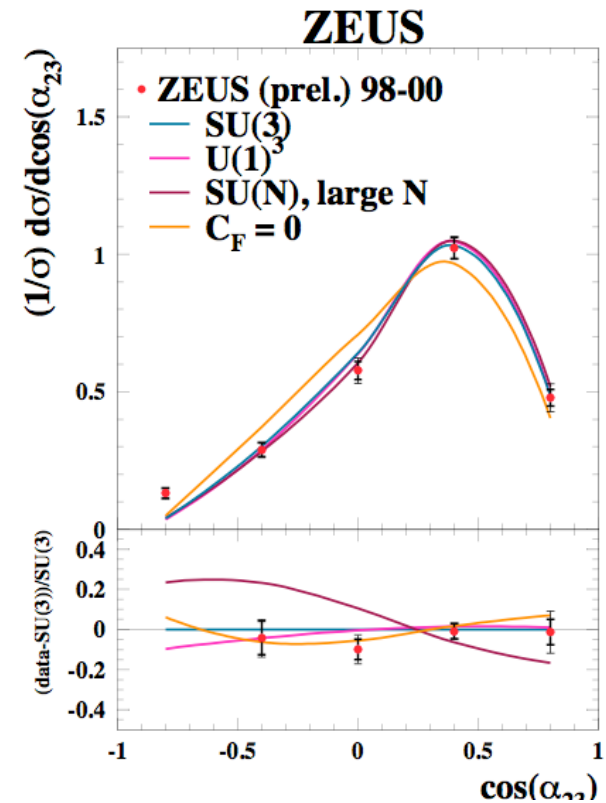
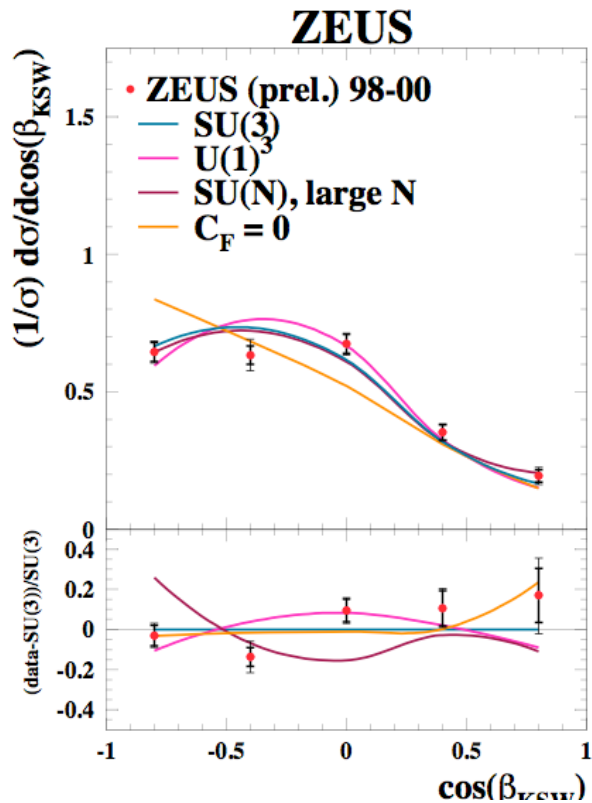

- ☛ C_F=0 and SU(N) large N disfavoured
- ☛ SU(3) [QCD] describes data
- ☛ similar to U(1)³ : no sensitivity to distinguish yet

Angular correlations

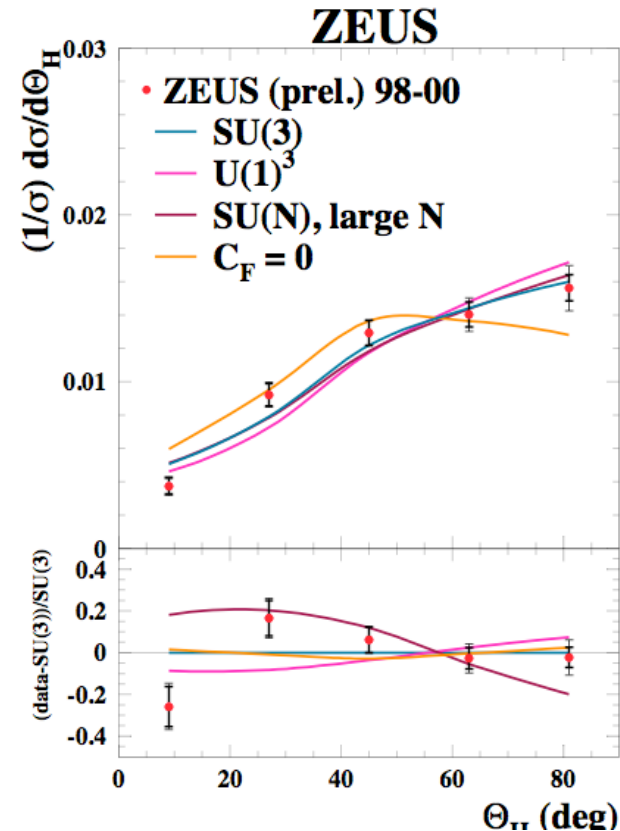
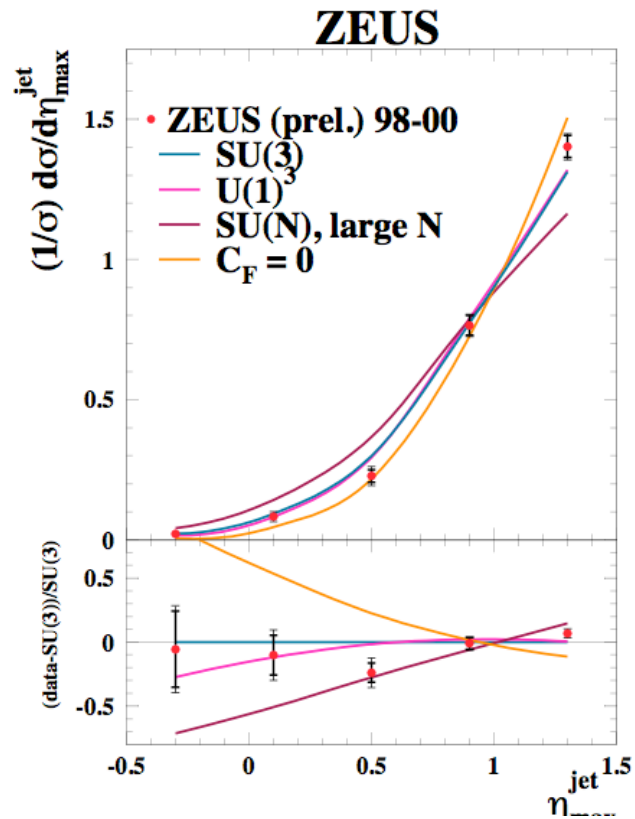

- ☛ $C_F=0$ and SU(N) large N disfavoured
- ☛ SU(3) [QCD] describes data
- ☛ similar to $U(1)^3$: no sensitivity to distinguish yet

Jets in charged current DIS

- Charged current DIS:
 - . Testing QCD and the electroweak sector of the Standard Model:
 - CC DIS jet cross sections sensitive to α_s and to M_W
 - . Sensitive to the presence of new physics
 - . HERA II data: longitudinally-polarized lepton beams

Jets in charged current DIS

Event selection:

180 pb⁻¹ e-p data

. $Q^2 > 200 \text{ GeV}^2$

. $y < 0.9$

1, 2 or 3 jets with

$-1 < \eta^{\text{jet}} < 2.5$

$E_{\text{t}}^{\text{jet } 1} > 14 \text{ GeV}$

$E_{\text{t}}^{\text{jet } 2} > 5 \text{ GeV}, E_{\text{t}}^{\text{jet } 3} > 5 \text{ GeV}$

* A few events with 4 jets *

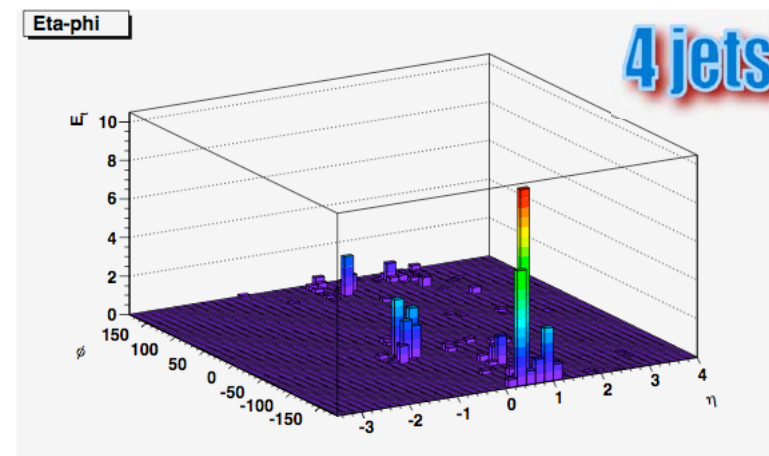
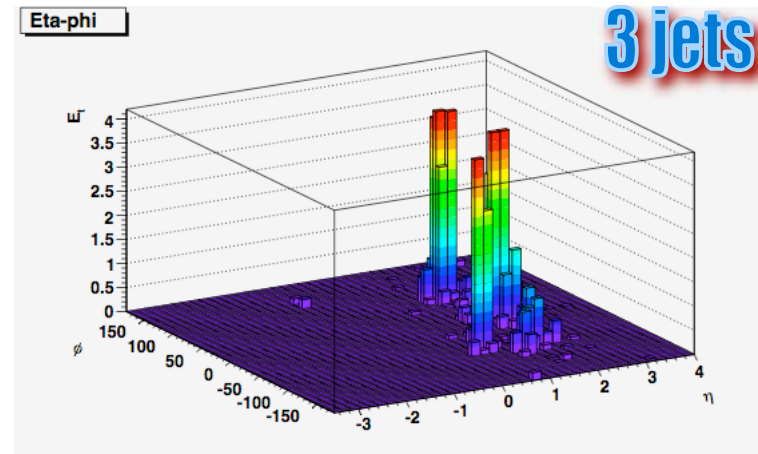

Jets in charged current DIS

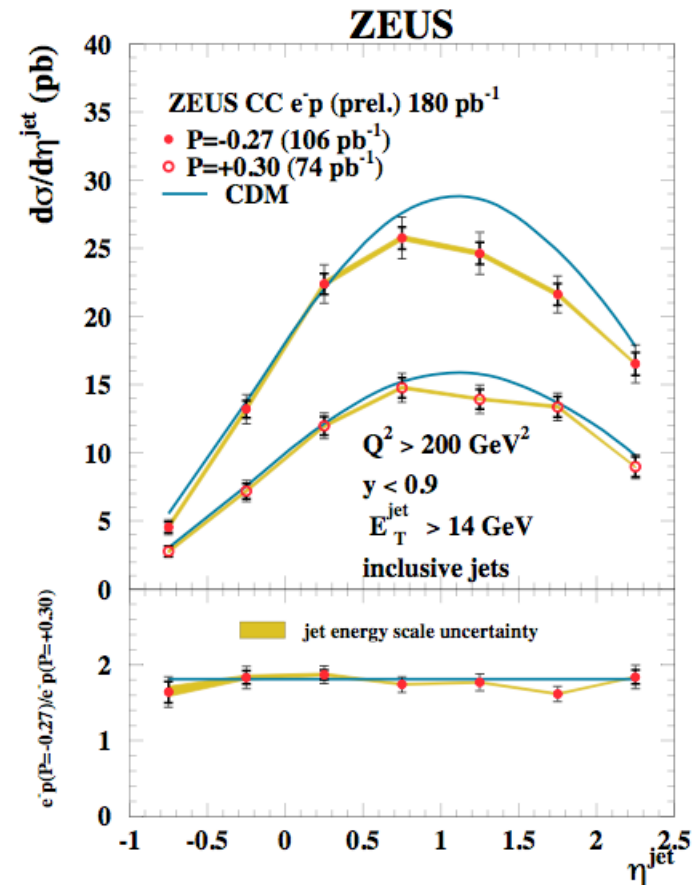
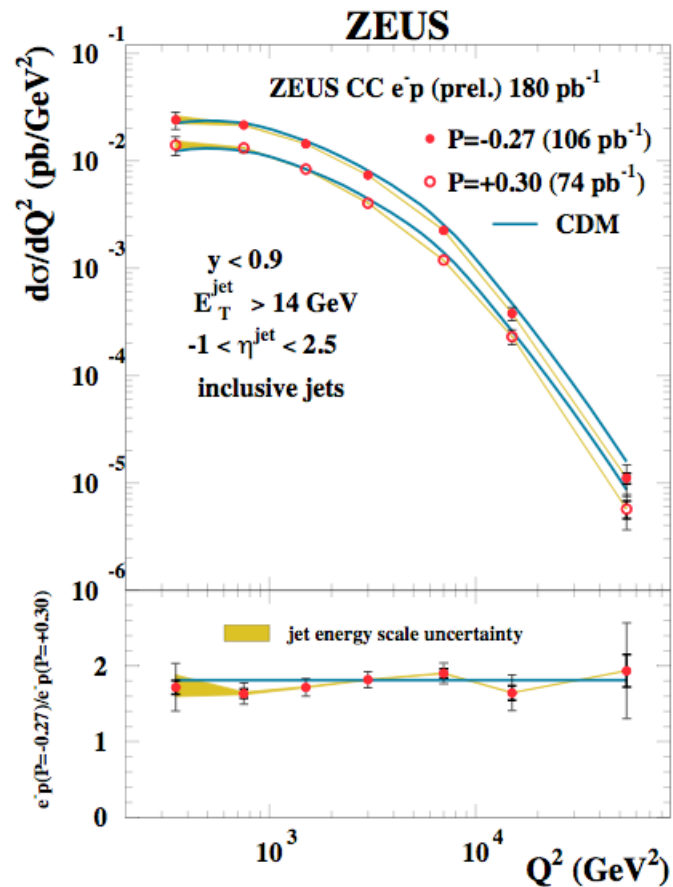

Inclusive jets: ratio of + and - polarized is well described by SM

Jets in charged current DIS

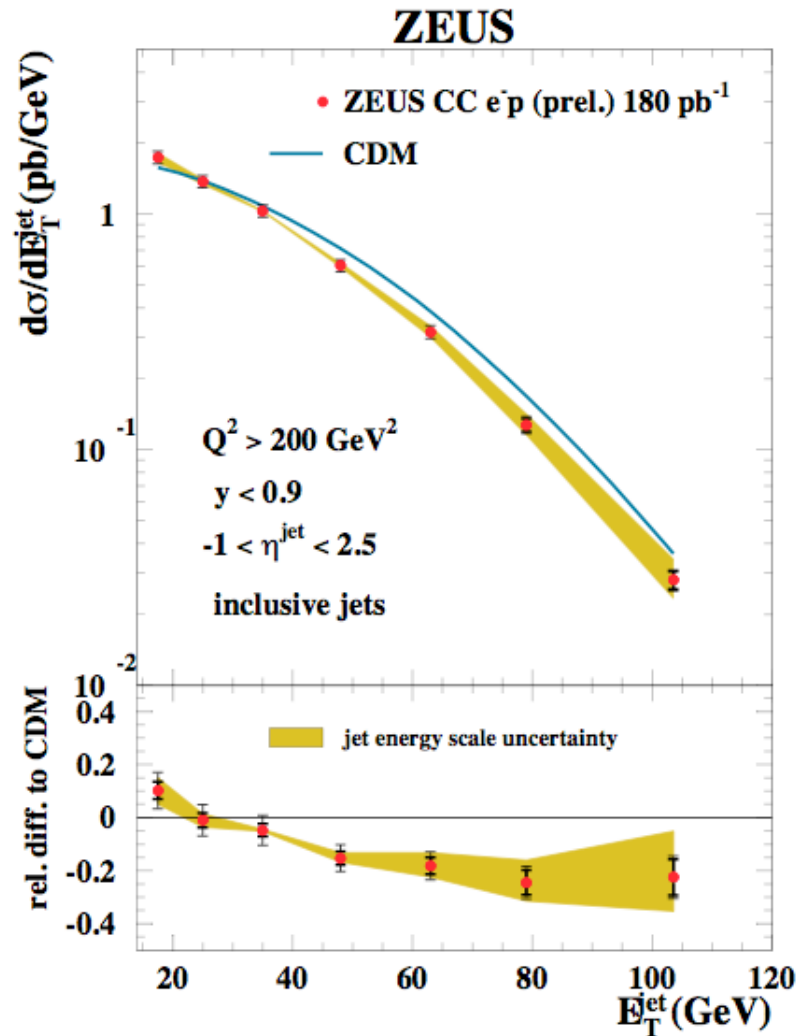

Inclusive jets:

unpolarized-corrected cross section is not well described by QCD

Jets in charged current DIS

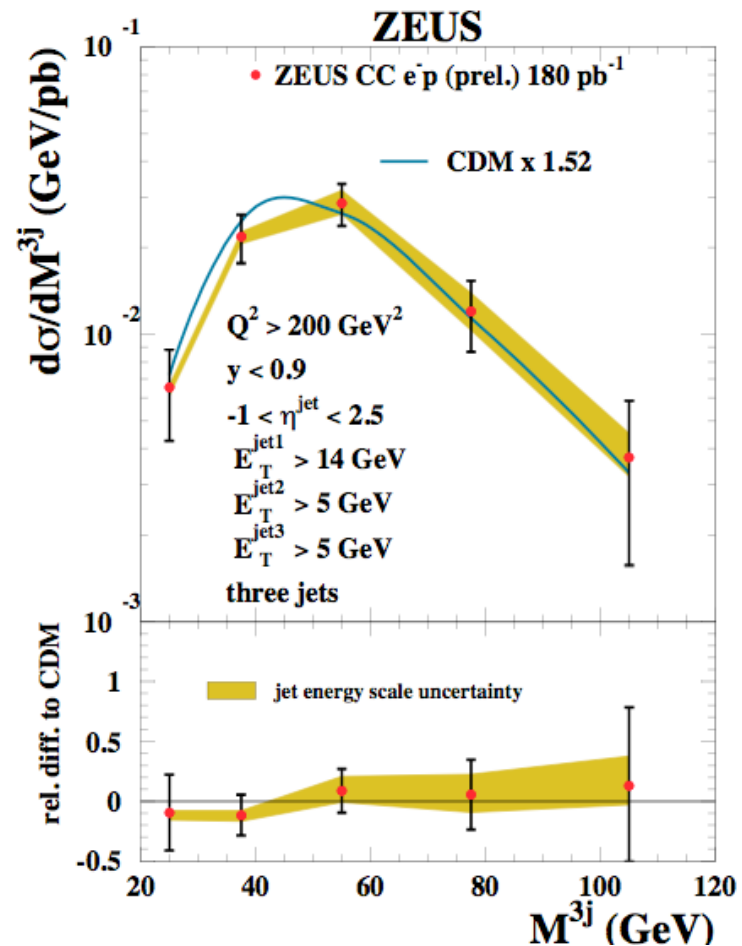
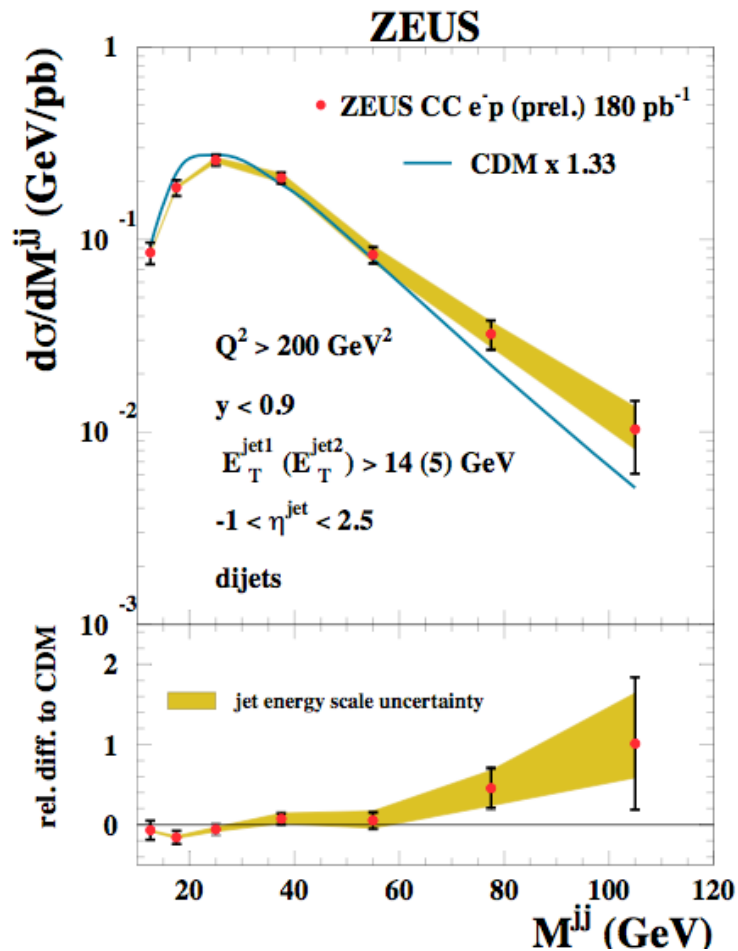

- **Two and three jets:** unpolarized-corrected cross section
- good agreement in shape with CDM (except dijet high mass)

Multijet in photoproduction

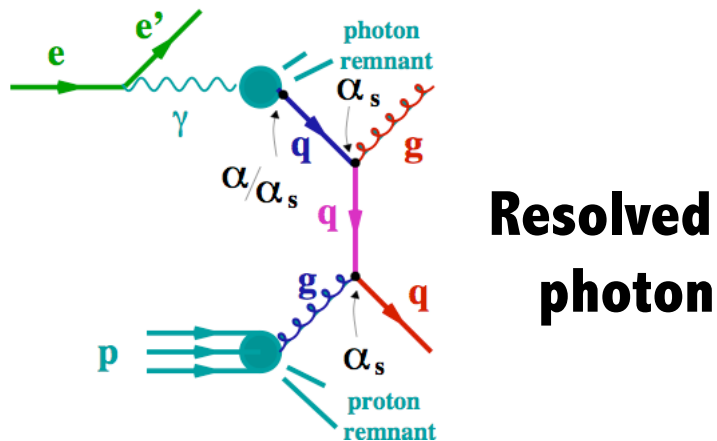
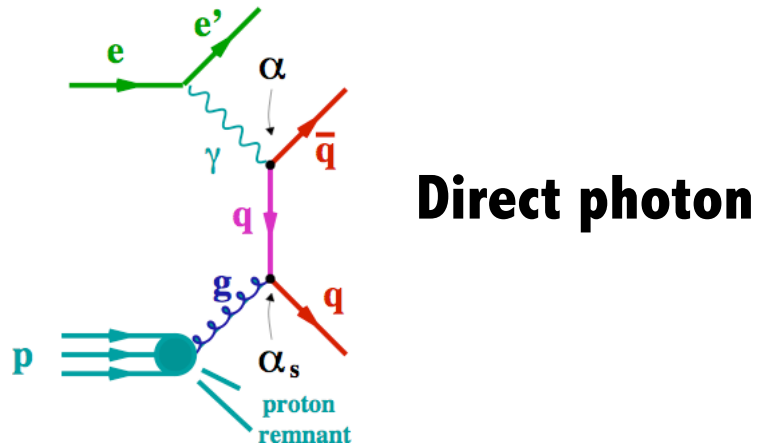

- PHP: Multi-Parton Interactions

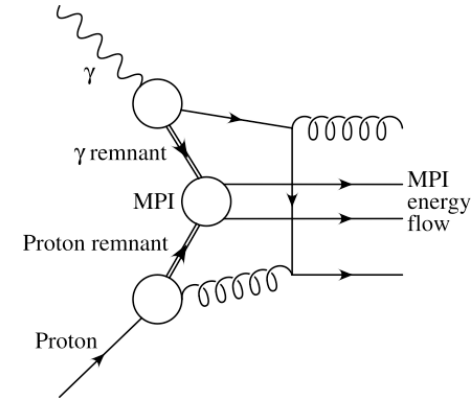

- . Multijet photoproduction (**resolved γ**) is sensitive to MPIs
- . 4-jet PHP: the highest order process ever measured at HERA
- . No NLO calculation available yet

Multijet in photoproduction

Event selection:

$$Q^2 < 1 \quad 0.2 < y < 0.85$$

3 or 4 jets with
 $|\eta| < 2.4 \quad E_T > 6 \text{ GeV}$

Two mass regions:

$$25 \leq M_{nj} \leq 50 \text{ GeV} \quad M_{nj} \geq 50 \text{ GeV}$$

(low mass more sensitive to MPIs)

MC with MPI improves
description of the data

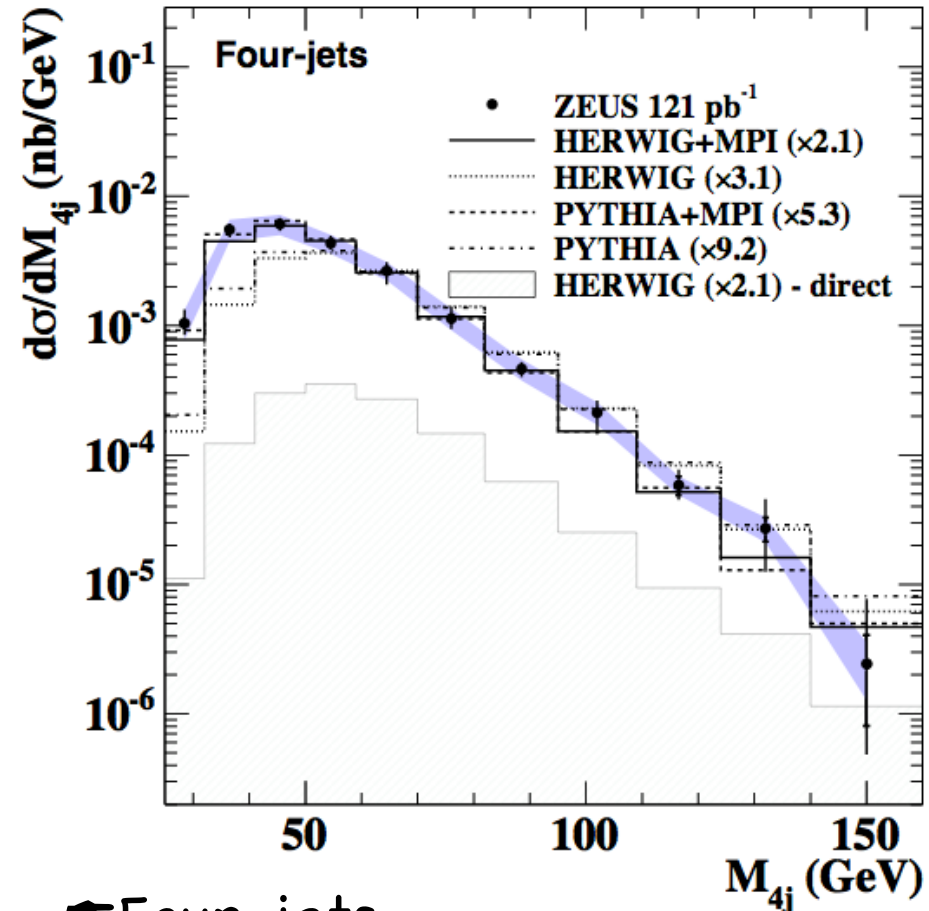

• Four-jets

• Similar results for three-jets

Multijet in photoproduction

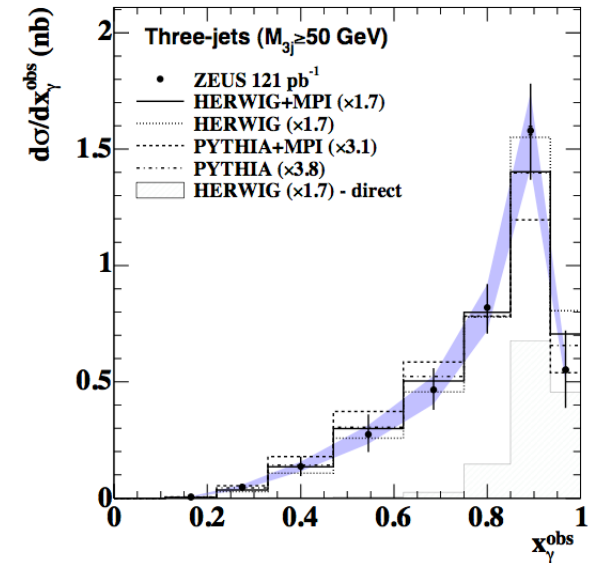
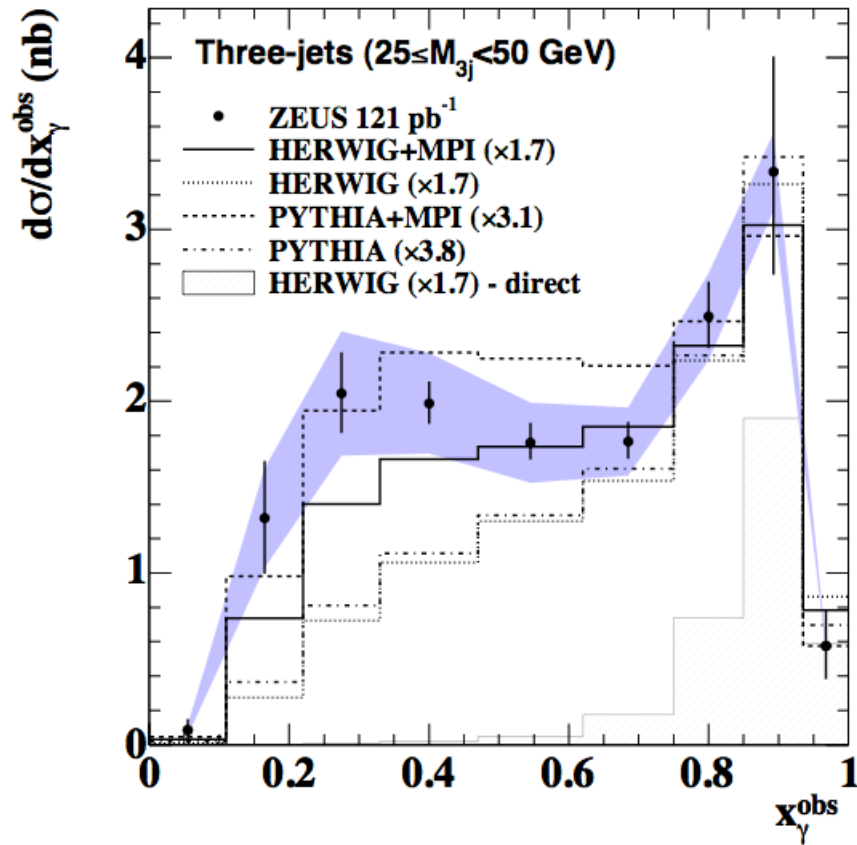

General improvement
adding MPIs to LO MC

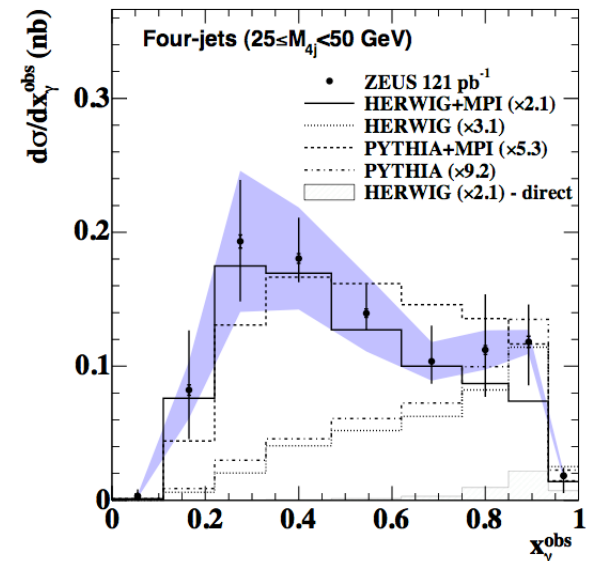

Mini-jets in DIS

. Minijets: multi parton interactions

Back to DIS: if P_T of interacting partons is larger than Q_2 : hadron-like (resolved) photon

Strategy:

Define and isolate a leading jet

Search for activity in regions of space where contributions from the primary interaction is expected to be small

Low (high) activity regions:

region which contains the least (most) transverse momentum

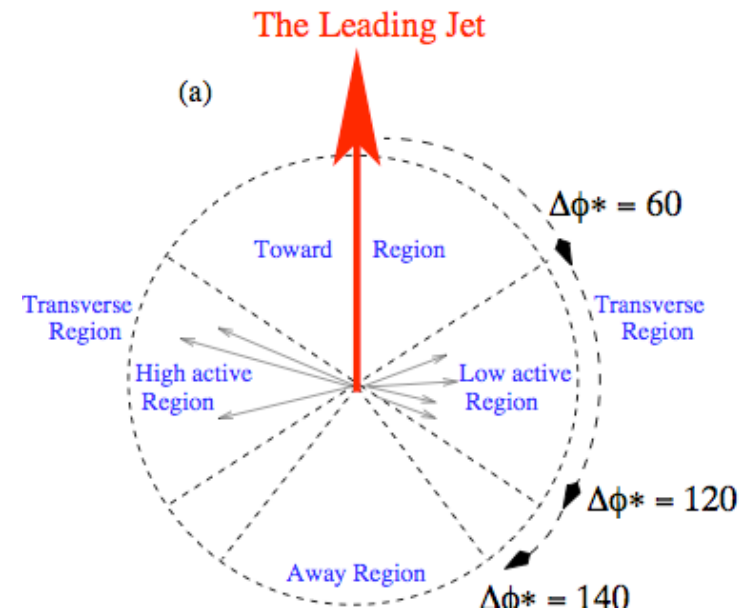

Mini-jets in DIS

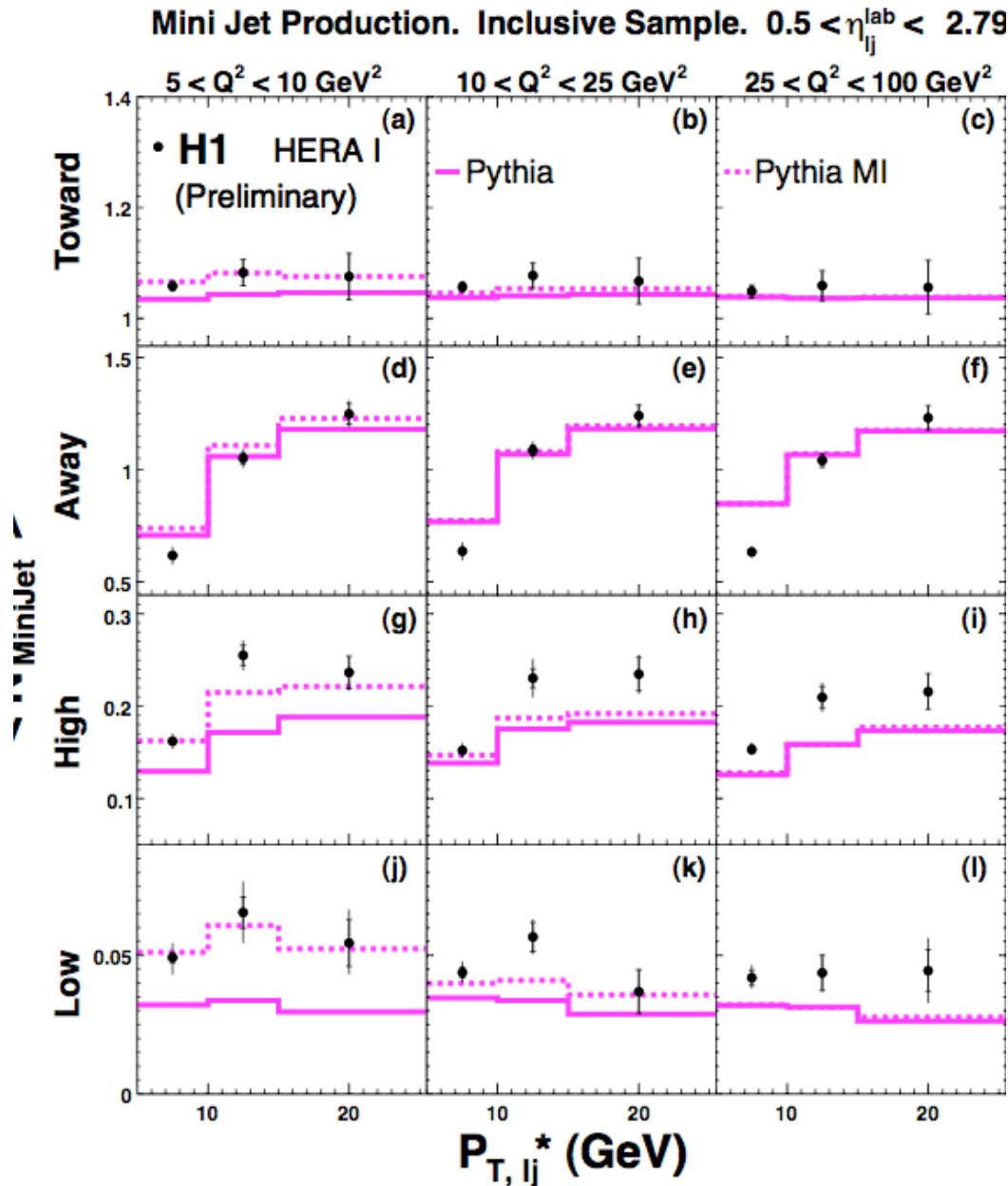

Average multiplicity of minijets as a function of leading jet P_T

At low Q^2 :

MPI improves agreement between PYTHIA and data

At higher Q^2 :

Little effect of MPI

[Activity regions defined in fig previous page] 23

Conclusions

- **Multijet in the forward region**
 - parton dynamics studied in the low- x_{bj} region where DGLAP expected to fail
 - agreement with data pretty much improved going from $O(\alpha_s^2)$ to $O(\alpha_s^3)$
- **Multijet in charged current DIS**
 - The cross sections ratios for +/- e beam polarization is well described by SM
 - LO MC (Colour Dipole Model): does not describe inclusive jets
reasonable for 2 jets, shape in agreement for three jets
- **Multijet in DIS: angular correlations btw jets:**
 - data consistent with admixture of colour configuration predicted by SU(3)
 - data disfavour $T_F/C_F \approx 0$ (as predicted by SU(N), large N) or $C_F=0$
 - Not enough sensitivity to distinguish btw gauge groups SU(3) and U(1)³
- **Minjets in DIS and Multijet in photoproduction**
 - At low Q^2 , adding MPIs to MCI models improved the description of the data